

Valid for Item-No.: 671221, 673285

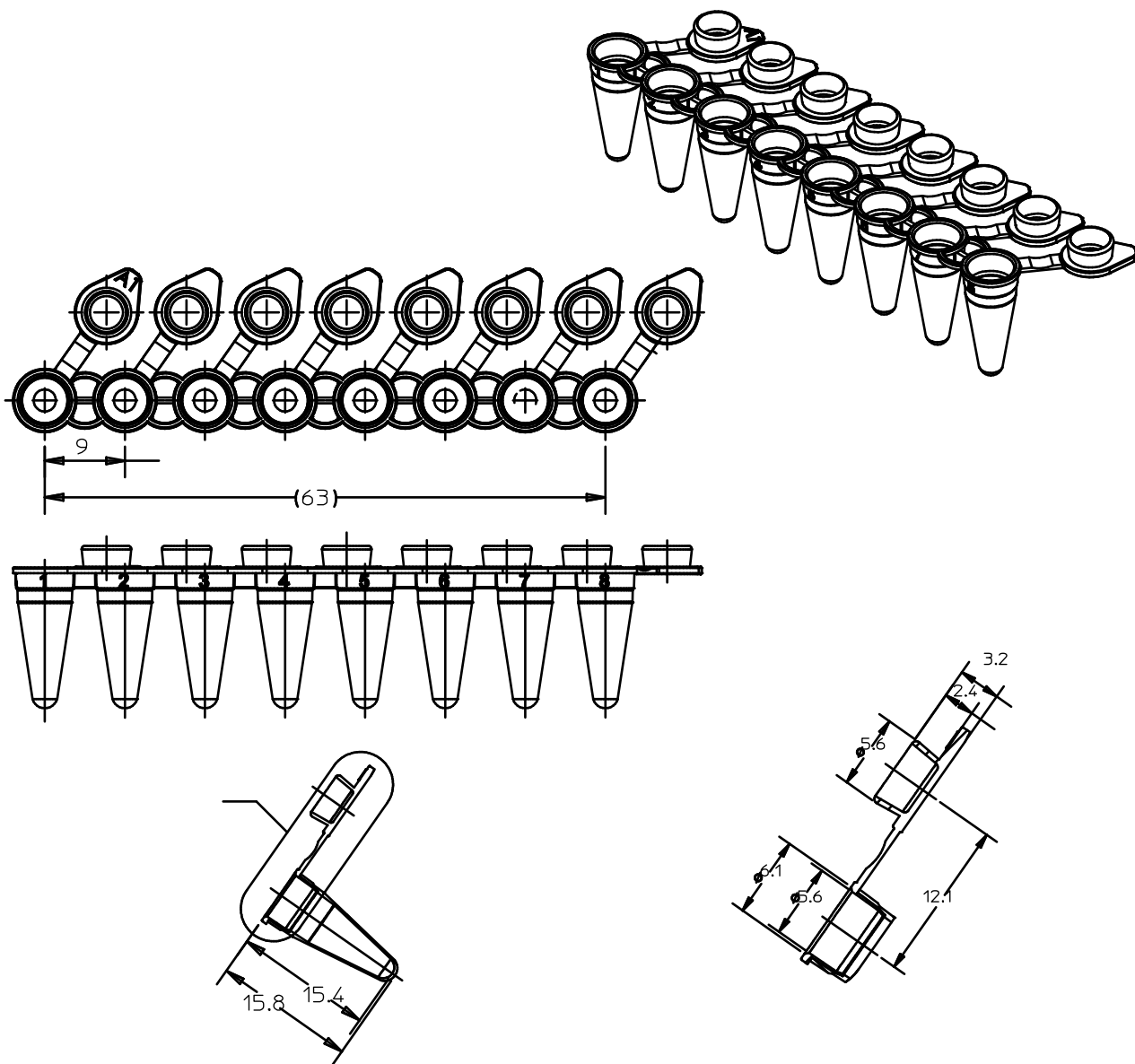

"All dimensions in mm"

Customer drawing subject to change without notice!

Uncontrolled Copy

Prior Issue	Drawn	Approved	Released	CONFIDENTIAL: Information contained in this document or drawing is confidential and proprietary to Greiner Bio-One GmbH. This document may not be reproduced for any reason without written permission from Greiner Bio-One GmbH. All rights of design, invention, and copyright are reserved.
Revision 5	Date 2016/10/19	Date 2024/07/12	Date 2024/07/12	
Date 2022/02/21	Name forb	Name kleber	Name ziegler	