

Valid for Item-No.: 683201, 683271, 683273, 683274, 683275, 683276, 683277

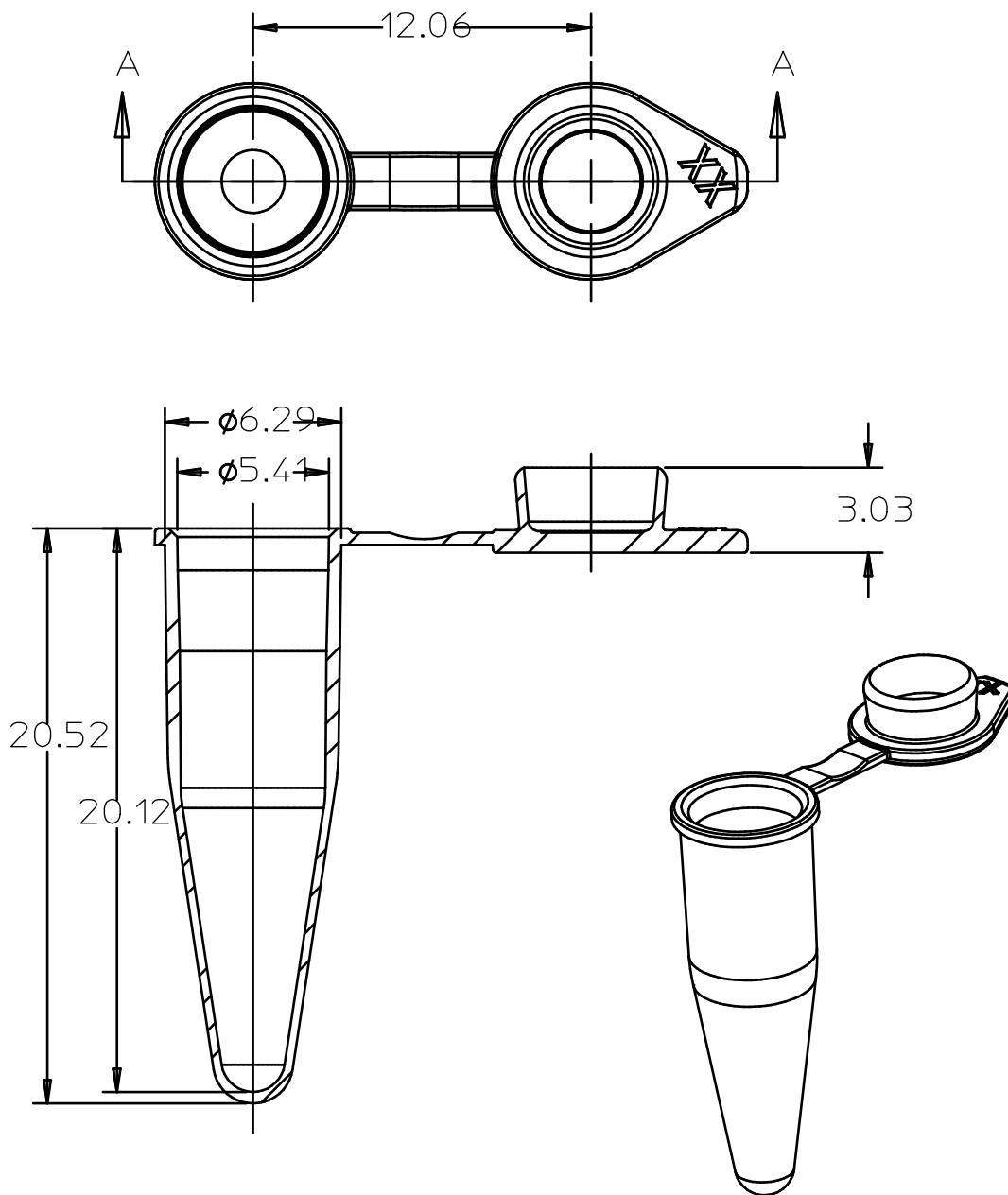

"All dimensions in mm"

Customer drawing subject to change without notice!

Uncontrolled Copy

Prior Issue	Drawn	Approved	Released	CONFIDENTIAL: Information contained in this document or drawing is confidential and proprietary to Greiner Bio-One GmbH. This document may not be reproduced for any reason without written permission from Greiner Bio-One GmbH. All rights of design, invention, and copyright are reserved.
Revision 3	Date 2011/08/15	Date 2022/01/25	Date 2022/02/15	
Date 2015/11/23	Name forb	Name forb	Name kleber	