

Valid for Item-No.: 187261, 187262

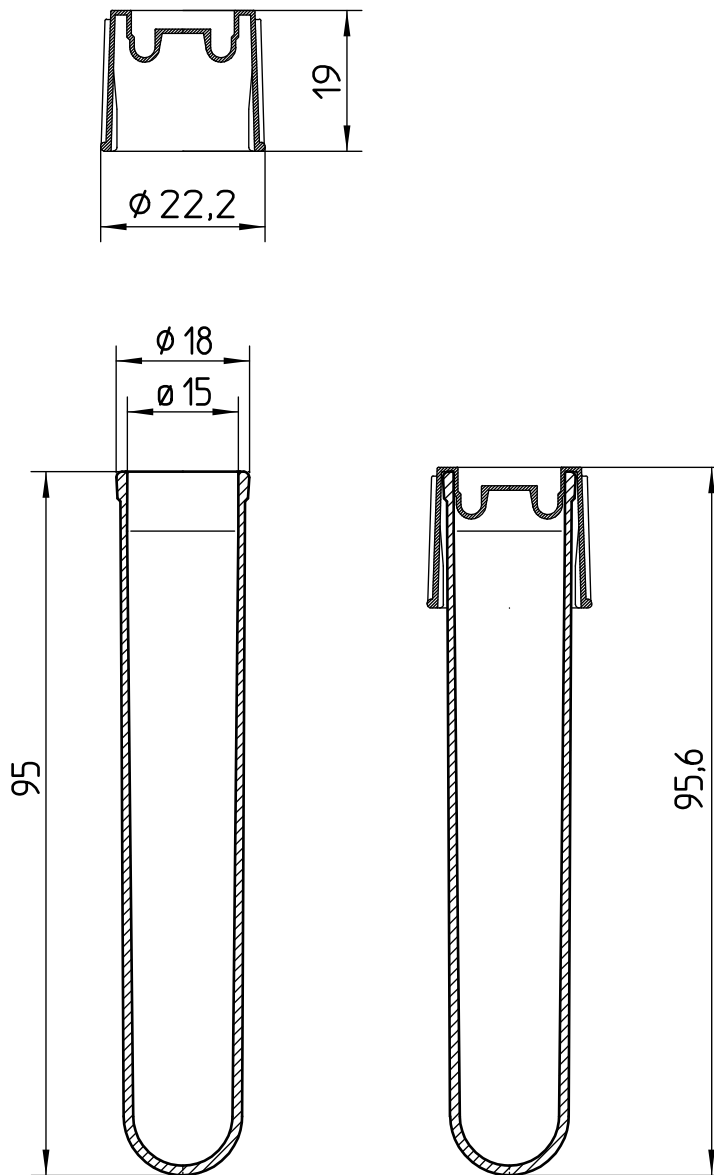

"All dimensions in mm"
Customer drawing subject to change without notice!

Uncontrolled Copy

Prior Issue	Drawn	Approved	Released	CONFIDENTIAL: Information contained in this document or drawing is confidential and proprietary to Greiner Bio-One GmbH. This document may not be reproduced for any reason without written permission from Greiner Bio-One GmbH. All rights of design, invention, and copyright are reserved.
Revision 2	Date 2011/04/18	Date 2022/11/04	Date 2022/11/07	
Date 2020/03/20	Name forb	Name forb	Name kleber	