

Valid for Item-No.: 346370, 346371, 346372

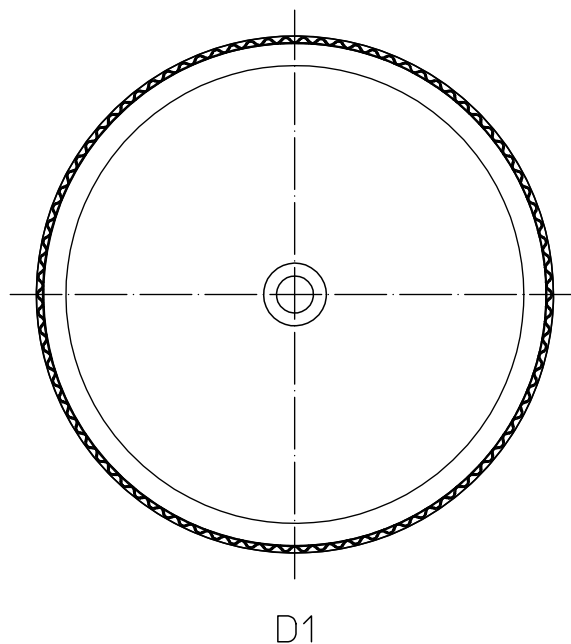
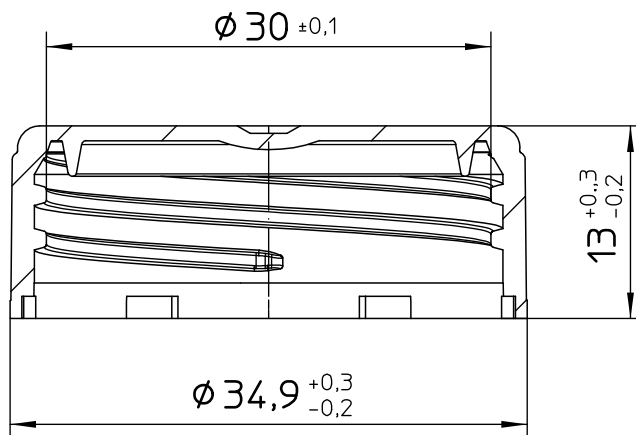
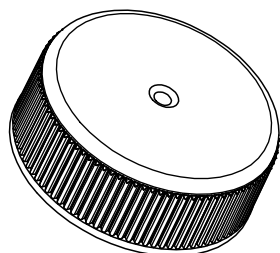

"All dimensions in mm"
Customer drawing subject to change without notice!

Uncontrolled Copy

Prior Issue	Drawn	Approved	Released	CONFIDENTIAL: Information contained in this document or drawing is confidential and proprietary to Greiner Bio-One GmbH. This document may not be reproduced for any reason without written permission from Greiner Bio-One GmbH. All rights of design, invention, and copyright are reserved.
Revision	Date 2020/10/13	Date 2020/11/05	Date 2020/11/05	
Date	Name forb	Name forb	Name sonntag	