

Valid for Item-No.: 201150, 201151, 201152, 201170, 201171, 201172

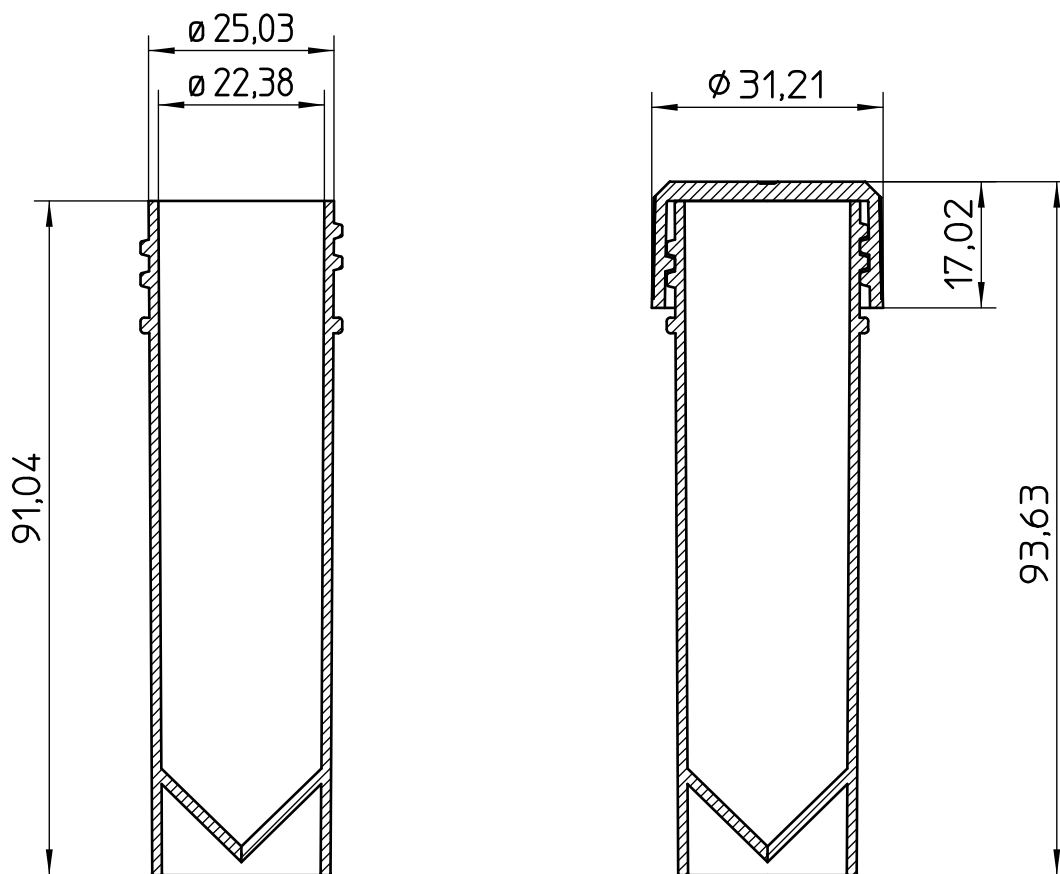

"All dimensions in mm"

Customer drawing subject to change without notice!

Uncontrolled Copy

Prior Issue	Drawn	Approved	Released	CONFIDENTIAL: Information contained in this document or drawing is confidential and proprietary to Greiner Bio-One GmbH. This document may not be reproduced for any reason without written permission from Greiner Bio-One GmbH. All rights of design, invention, and copyright are reserved.
Revision	Date	Date	Date	
2	2011/04/15	2021/05/03	2021/05/03	
Date	Name	Name	Name	
2011/08/29	forb	forb	schwarzj	