

Valid for Item-No.: 771350, 771360, 772350, 772360

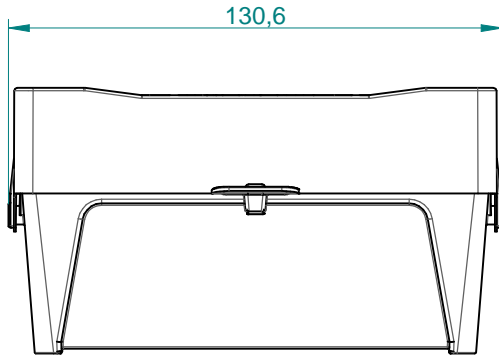

Front View

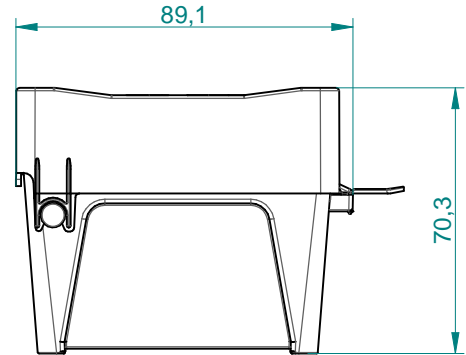

Side View

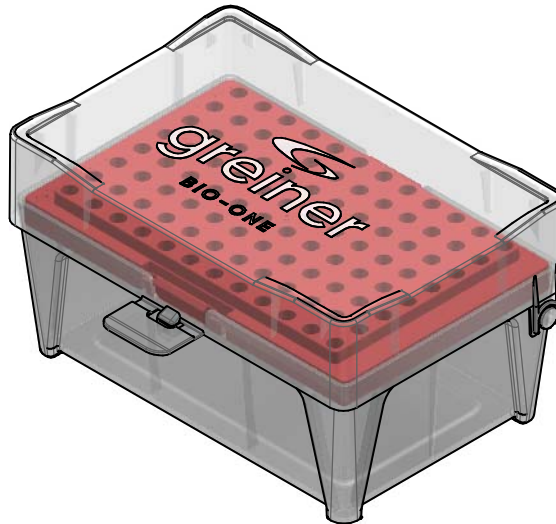

"All dimensions in mm"

Customer drawing subject to change without notice!

Uncontrolled Copy

Prior Issue	Drawn	Approved	Released	<small>CONFIDENTIAL:</small> Information contained in this document or drawing is confidential and proprietary to Greiner Bio-One GmbH. This document may not be reproduced for any reason without written permission from Greiner Bio-One GmbH. All rights of design, invention, and copyright are reserved.
Revision 770310.00	Date 22.09.2021	Date Sep.2021	Date Sep.2021	
Date 29.04.2019	Name M. Salinger	Name J. Gaiser	Name R. Heller	