

Valid for Item-No.: 716201

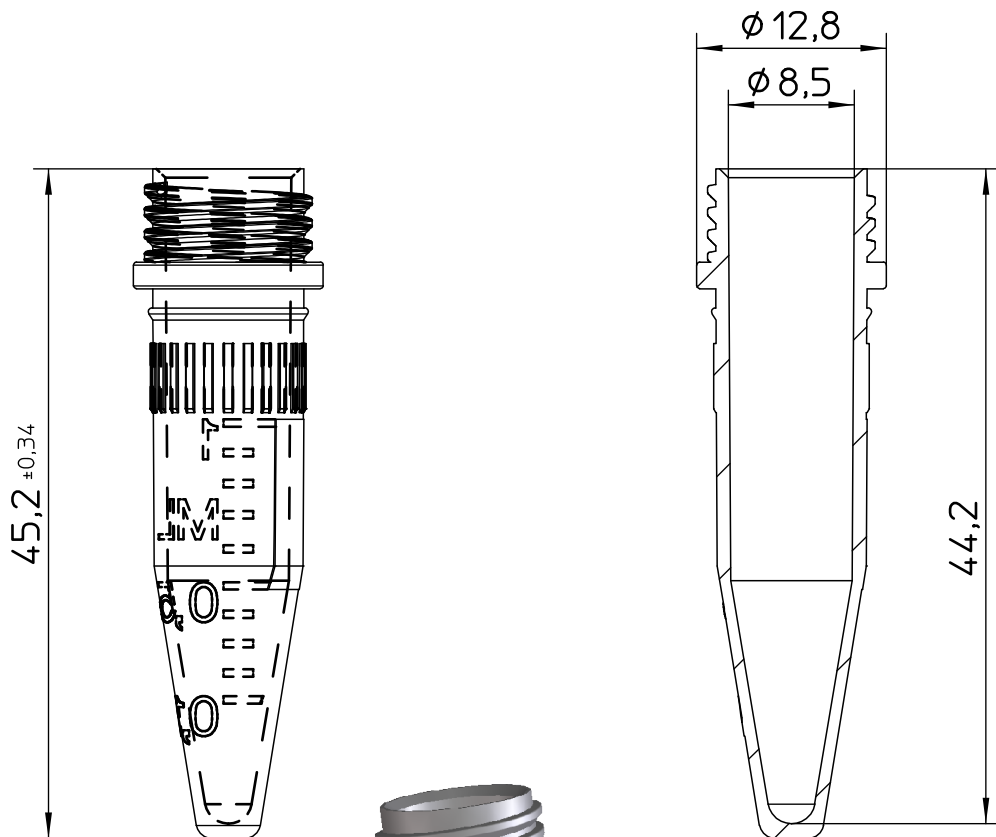

"All dimensions in mm"

Customer drawing subject to change without notice!

Uncontrolled Copy

Prior Issue	Drawn	Approved	Released	CONFIDENTIAL: Information contained in this document or drawing is confidential and proprietary to Greiner Bio-One GmbH. This document may not be reproduced for any reason without written permission from Greiner Bio-One GmbH. All rights of design, invention, and copyright are reserved.
Revision 5	Date 2011/08/16	Date 2022/01/24	Date 2022/02/17	
Date 2013/02/28	Name forb	Name forb	Name schwarzj	