

Valid for Item-No.: 657102, 657910, 657920, 657930, 657940, 657950, 657960, 657970

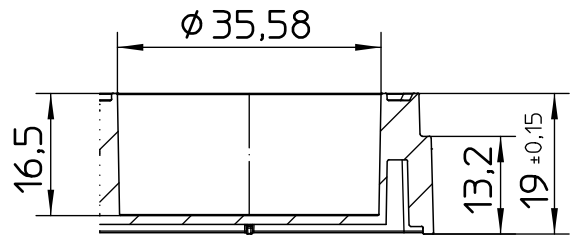

Curvature \updownarrow Max.Diff 0.20

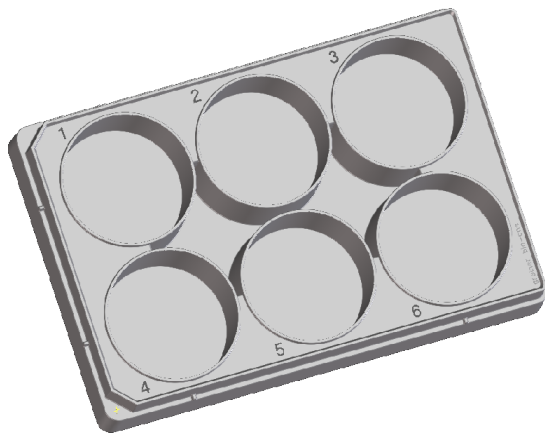
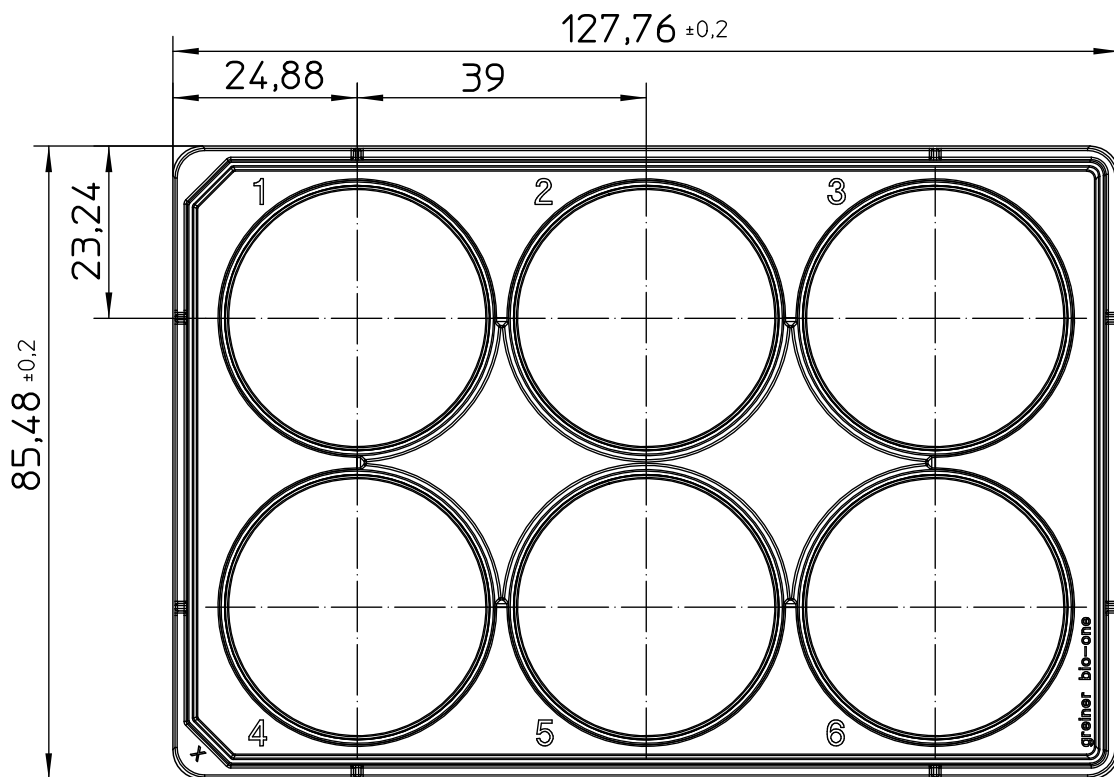
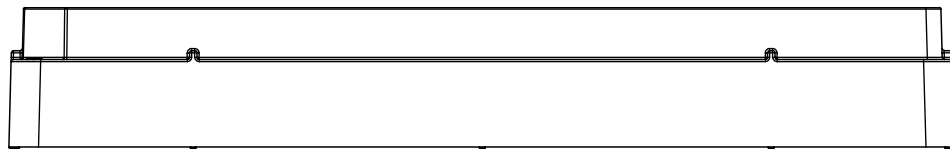

"All dimensions in mm"

Customer drawing subject to change without notice!

Uncontrolled Copy

| Prior Issue | Drawn | Approved | Released | CONFIDENTIAL: Information contained in this document or drawing is confidential and proprietary to Greiner Bio-One GmbH. This document may not be reproduced for any reason without written permission from Greiner Bio-One GmbH. All rights of design, invention, and copyright are reserved. |
|-----------------|-----------------|-----------------|-----------------|--|
| Revision 4 | Date 2018/11/19 | Date 2022/11/08 | Date 2022/11/08 | |
| Date 2020/03/11 | Name forb | Name forb | Name kleber | |

Valid for Item-No.: 657102, 657910, 657920, 657930, 657940, 657950, 657960, 657970

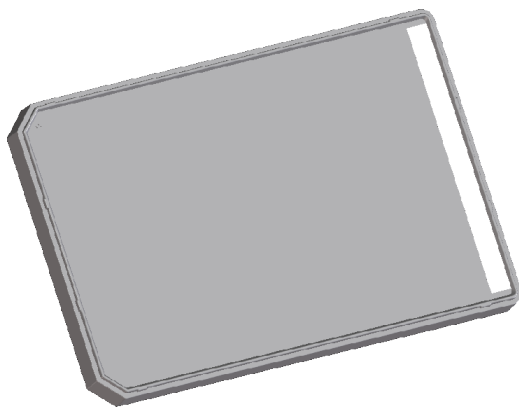

Curvature +0.3
-0.1

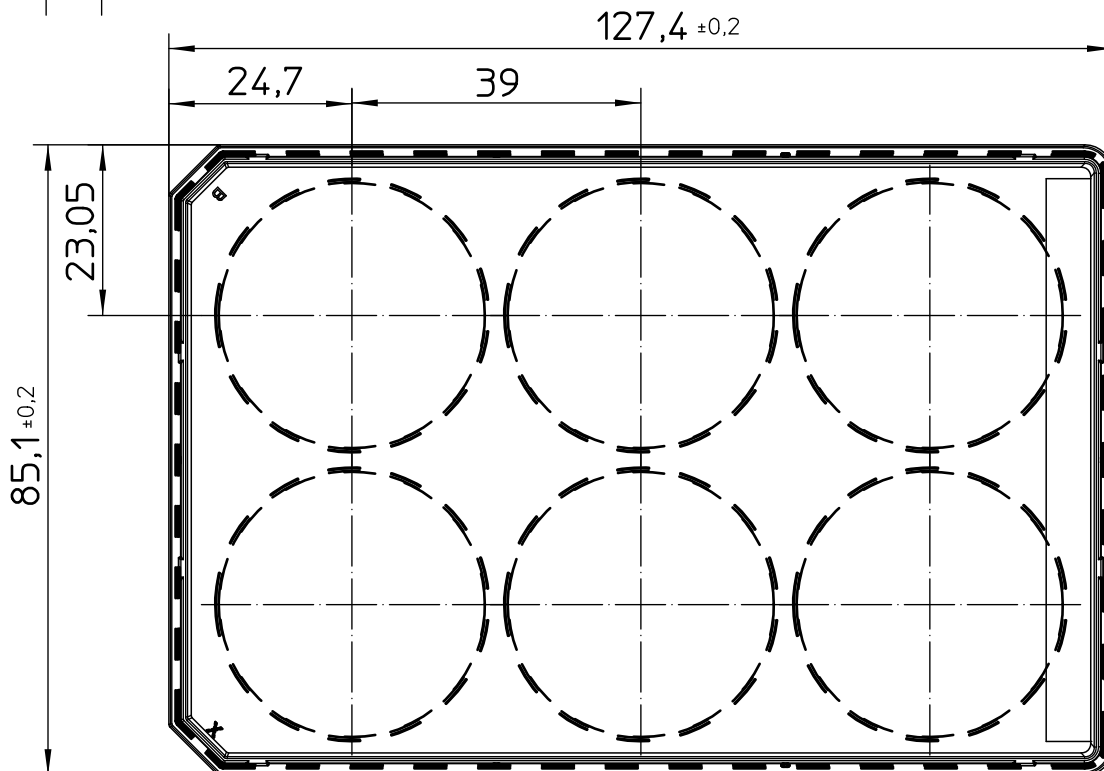
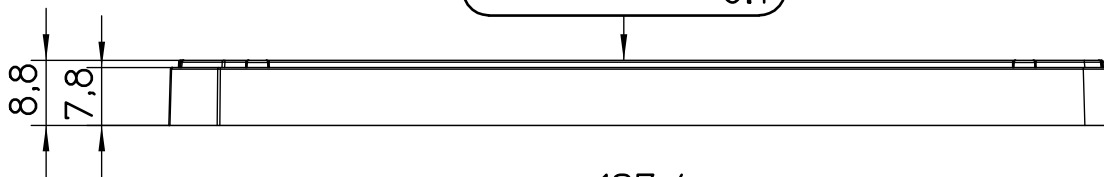

"All dimensions in mm"

Customer drawing subject to change without notice!

Uncontrolled Copy

| Prior Issue | Drawn | Approved | Released | CONFIDENTIAL: Information contained in this document or drawing is confidential and proprietary to Greiner Bio-One GmbH. This document may not be reproduced for any reason without written permission from Greiner Bio-One GmbH. All rights of design, invention, and copyright are reserved. |
|-----------------|-----------------|-----------------|-----------------|--|
| Revision 4 | Date 2018/11/19 | Date 2022/11/08 | Date 2022/11/08 | |
| Date 2020/03/11 | Name forb | Name forb | Name kleber | |