

Valid for Item-No.: 705063, 705065, 705066, 705070, 705071, 705073, 705074, 705075, 705076, 705084, 705185

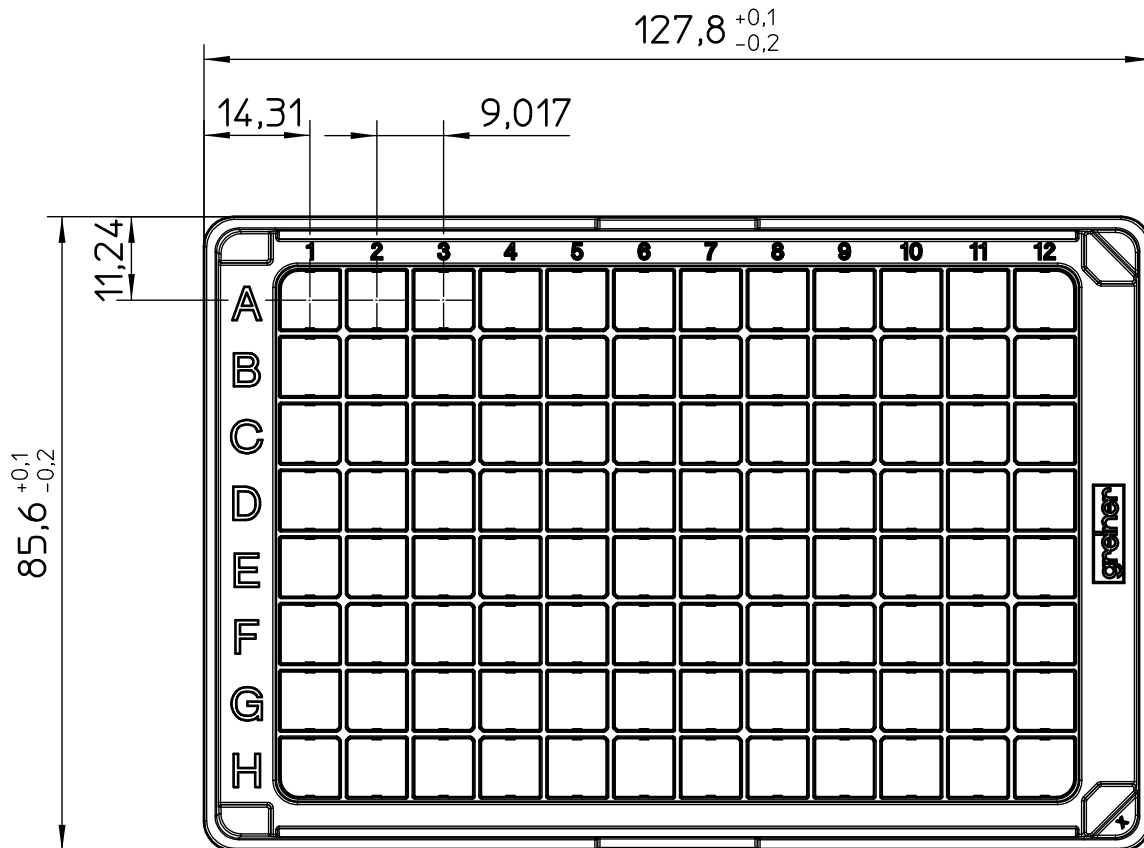
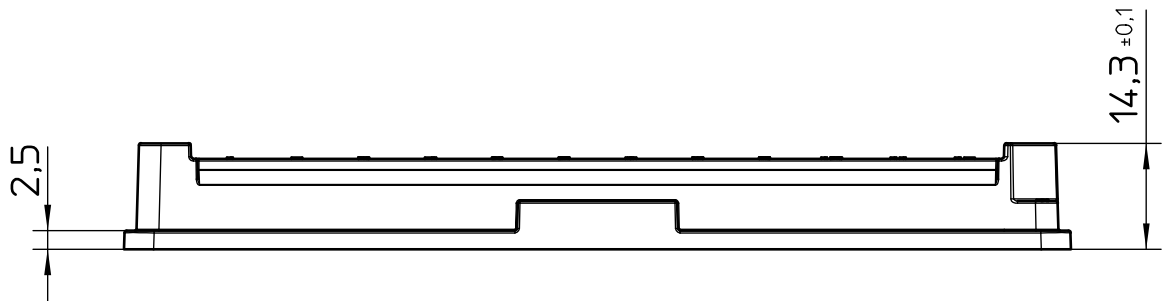

"All dimensions in mm"

Customer drawing subject to change without notice!

Uncontrolled Copy

Prior Issue	Drawn	Approved	Released	CONFIDENTIAL: Information contained in this document or drawing is confidential and proprietary to Greiner Bio-One GmbH. This document may not be reproduced for any reason without written permission from Greiner Bio-One GmbH. All rights of design, invention, and copyright are reserved.
Revision 7	Date 2011/08/16	Date 2024/07/11	Date 2024/07/11	
Date 2021/08/11	Name forb	Name kleber	Name ziegler	

Valid for Item-No.: 705063, 705065, 705066, 705070, 705071, 705073, 705074, 705075, 705076, 705084, 705185

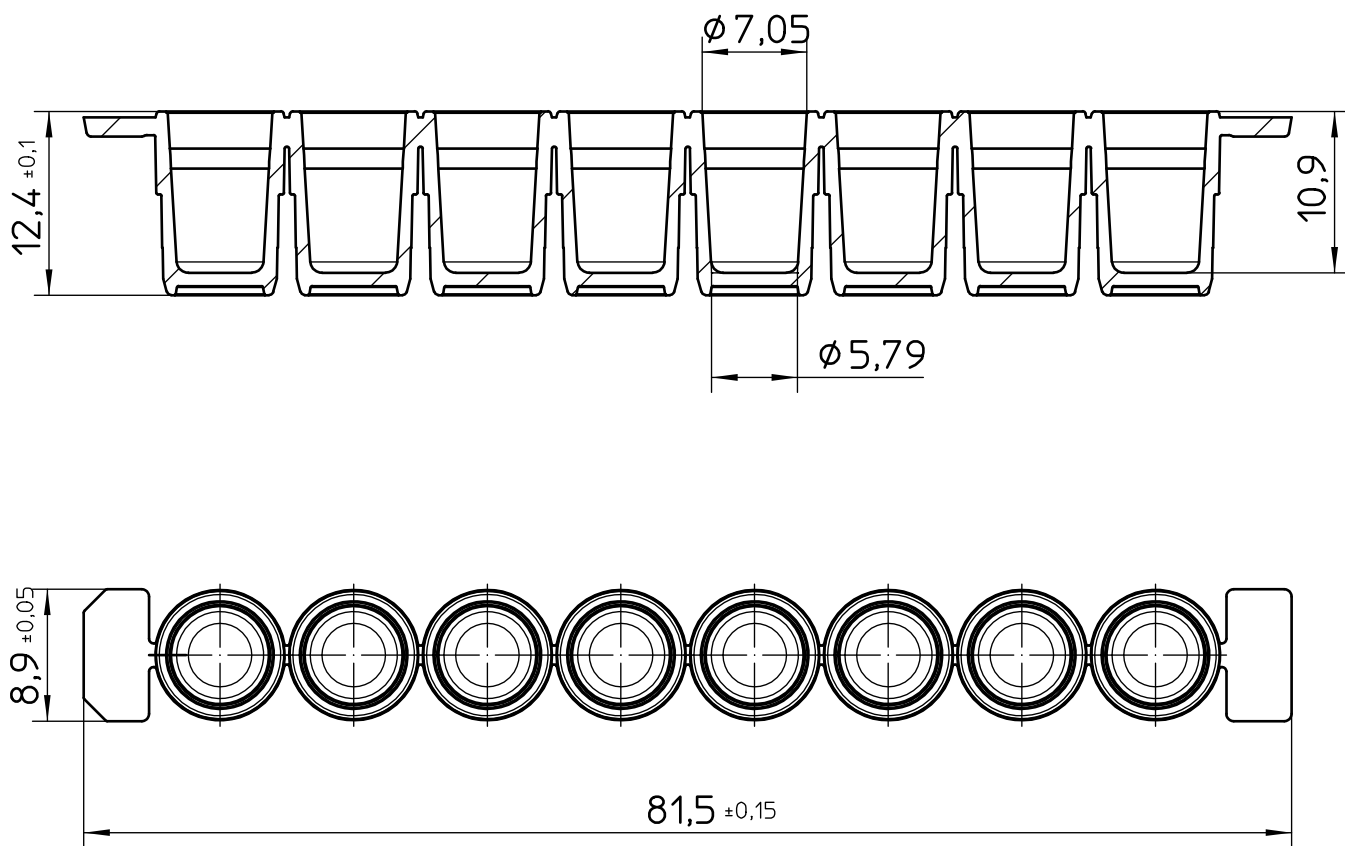

"All dimensions in mm"

Customer drawing subject to change without notice!

Uncontrolled Copy

Prior Issue	Drawn	Approved	Released	CONFIDENTIAL: Information contained in this document or drawing is confidential and proprietary to Greiner Bio-One GmbH. This document may not be reproduced for any reason without written permission from Greiner Bio-One GmbH. All rights of design, invention, and copyright are reserved.
Revision 7	Date 2011/08/16	Date 2024/07/11	Date 2024/07/11	
Date 2021/08/11	Name forb	Name kleber	Name ziegler	