

Valid for Item-No.: 678116-CF1, 678916-CF1

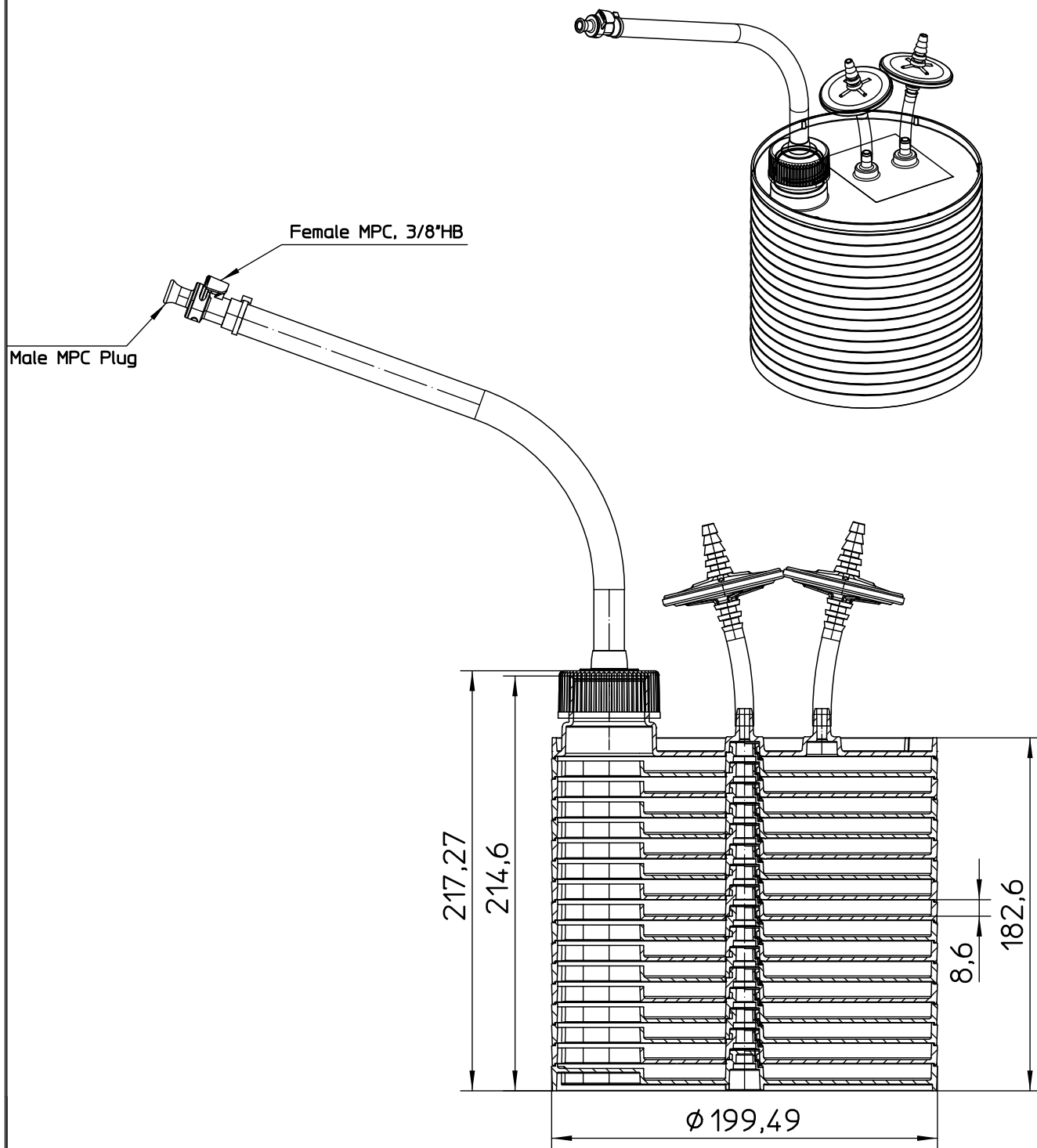

"All dimensions in mm"

Customer drawing subject to change without notice!

Uncontrolled Copy

Prior Issue	Drawn	Approved	Released	CONFIDENTIAL: Information contained in this document or drawing is confidential and proprietary to Greiner Bio-One GmbH. This document may not be reproduced for any reason without written permission from Greiner Bio-One GmbH. All rights of design, invention, and copyright are reserved.
Revision	Date	Date	Date	
2	2020/04/14	2022/11/07	2022/11/07	
Date	Name	Name	Name	
2022/08/03	schwarzj	kleber	forb	