

Valid for Item-No.: 781866, 781716, 781726, 781736, 781741, 781743, 781745, 781746, 781752, 781756, 781757, 781766, 781866-128

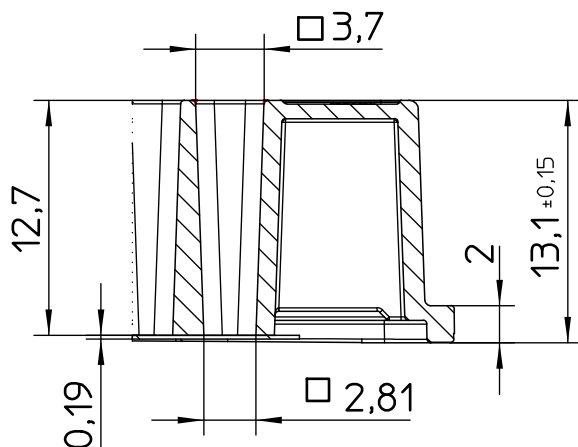

Curvature \updownarrow Max.Diff 0.15

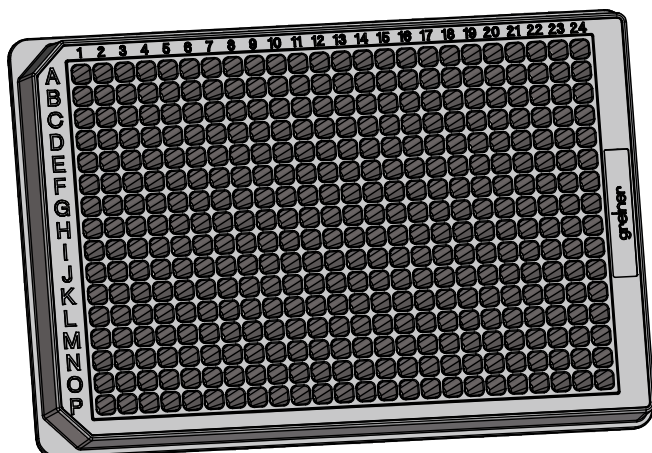
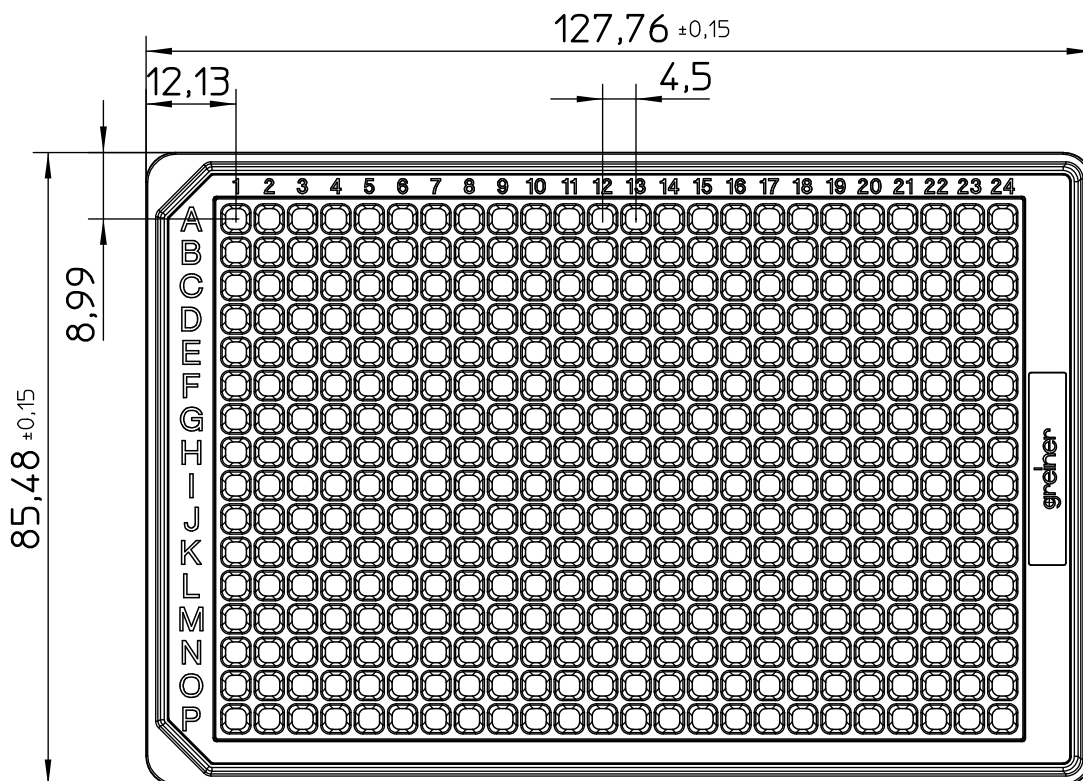
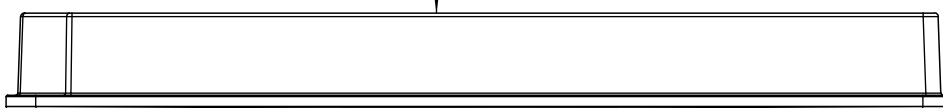

"All dimensions in mm"

Customer drawing subject to change without notice!

Uncontrolled Copy

| Prior Issue | Drawn | Approved | Released | CONFIDENTIAL: Information contained in this document or drawing is confidential and proprietary to Greiner Bio-One GmbH. This document may not be reproduced for any reason without written permission from Greiner Bio-One GmbH. All rights of design, invention, and copyright are reserved. |
|-----------------|-----------------|-----------------|-----------------|--|
| Revision 2 | Date 2017/01/25 | Date 2024/02/19 | Date 2024/02/19 | |
| Date 2024/02/14 | Name schwarzej | Name kessler | Name kleber | |

Valid for Item-No.: 781866, 781716, 781726, 781736, 781741, 781743, 781745, 781746, 781752, 781756, 781757, 781766, 781866-128

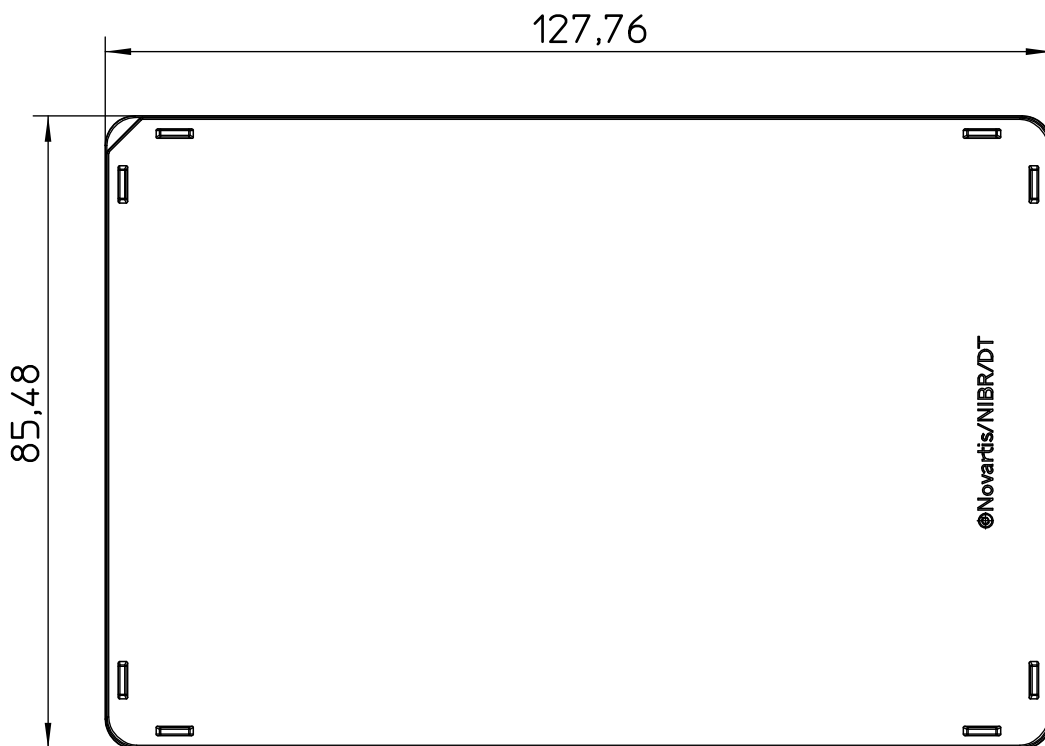
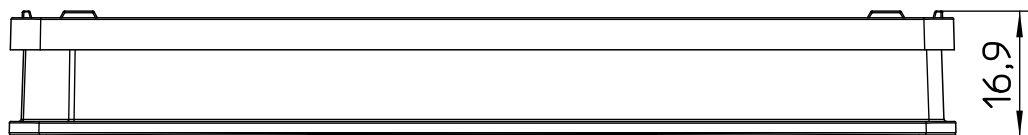
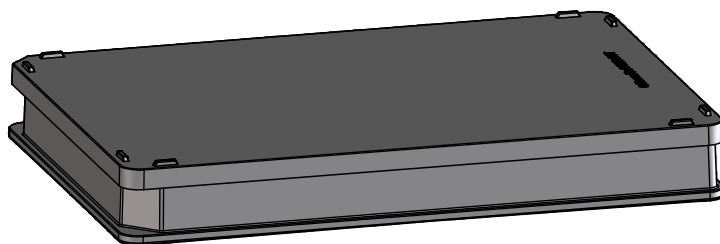

"All dimensions in mm"

Customer drawing subject to change without notice!

Uncontrolled Copy

| Prior Issue | Drawn | Approved | Released | CONFIDENTIAL: Information contained in this document or drawing is confidential and proprietary to Greiner Bio-One GmbH. This document may not be reproduced for any reason without written permission from Greiner Bio-One GmbH. All rights of design, invention, and copyright are reserved. |
|--------------------|--------------------|--------------------|--------------------|--|
| Revision 2 | Date 2017/01/25 | Date 2024/02/19 | Date 2024/02/19 | |
| Date 2024/02/14 | Name schwarzj | Name kessler | Name kleber | |