

Valid for Item-No.: 673286, 673287

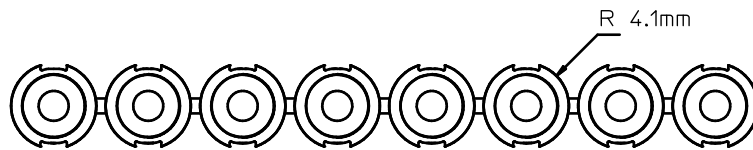
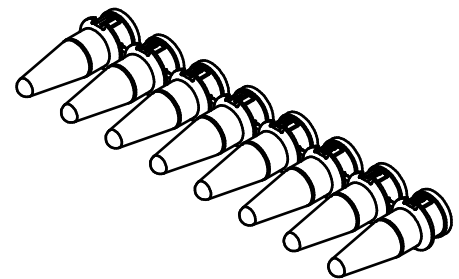
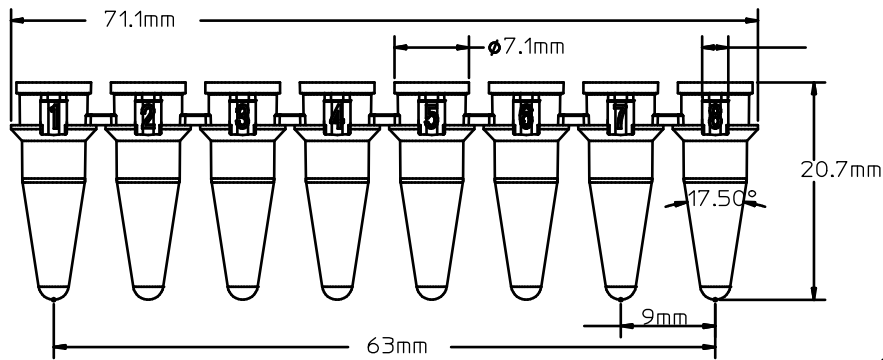

"All dimensions in mm"

Customer drawing subject to change without notice!

Uncontrolled Copy

Prior Issue	Drawn	Approved	Released	CONFIDENTIAL: Information contained in this document or drawing is confidential and proprietary to Greiner Bio-One GmbH. This document may not be reproduced for any reason without written permission from Greiner Bio-One GmbH. All rights of design, invention, and copyright are reserved.
Revision 1	Date 2017/01/26	Date 2022/11/11	Date 2022/11/14	
Date 2017/01/26	Name forb	Name forb	Name kleber	