

Valid for Item-No.: 781866, 781716, 781726, 781736, 781741, 781743, 781745, 781746, 781752, 781756, 781757, 781766, 781866-128

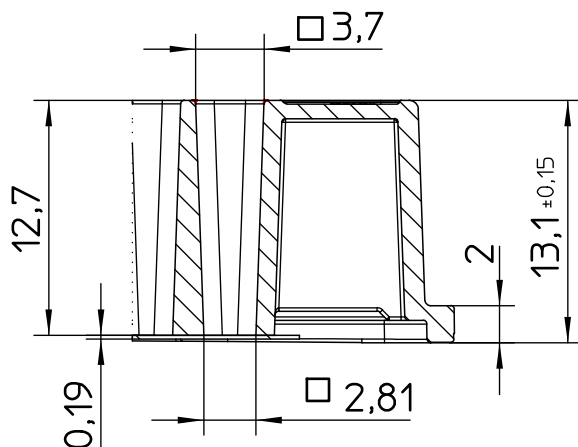

Curvature  $\updownarrow$  Max.Diff 0.15

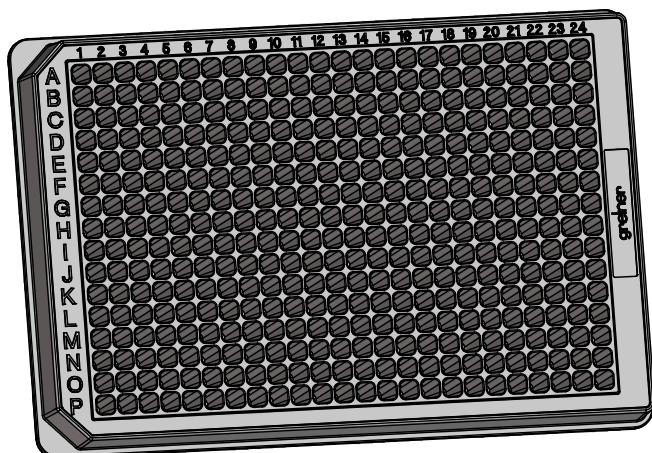
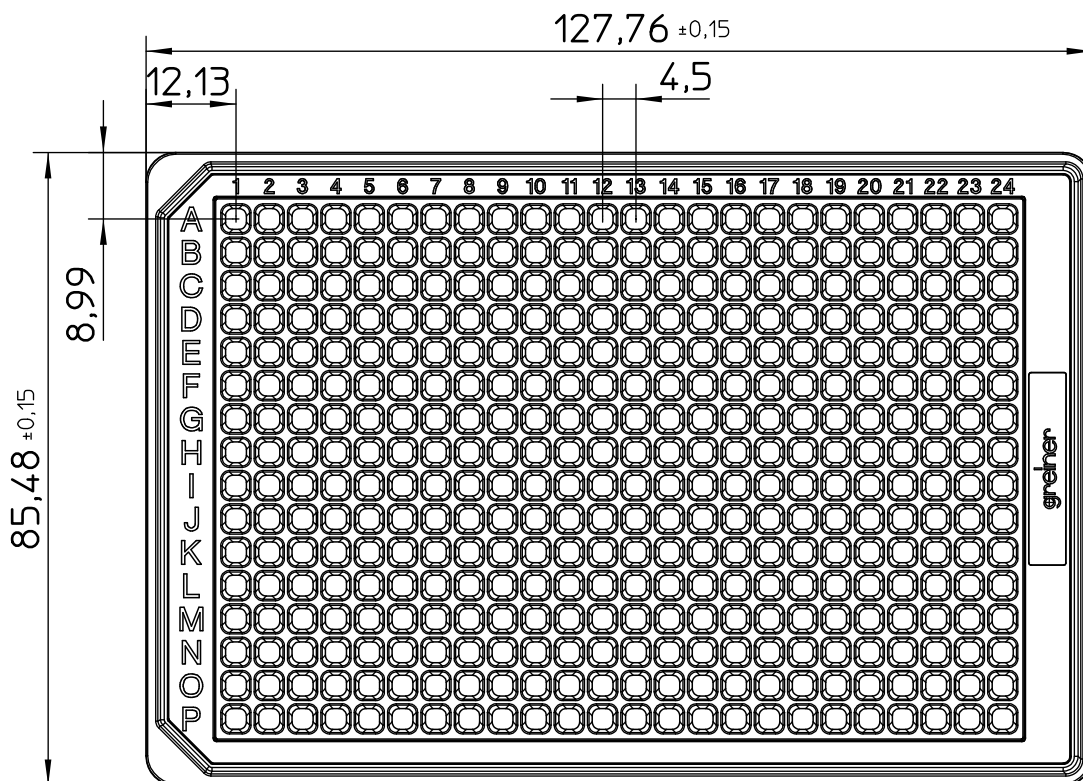
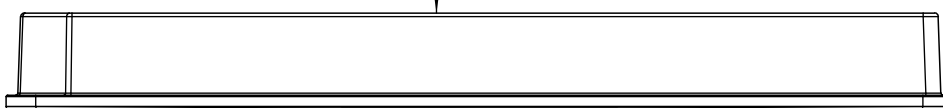

"All dimensions in mm"

Customer drawing subject to change without notice!

Uncontrolled Copy

Prior Issue	Drawn	Approved	Released	CONFIDENTIAL: Information contained in this document or drawing is confidential and proprietary to Greiner Bio-One GmbH. This document may not be reproduced for any reason without written permission from Greiner Bio-One GmbH. All rights of design, invention, and copyright are reserved.
Revision 2	Date 2017/01/25	Date 2024/02/19	Date 2024/02/19	
Date 2024/02/14	Name schwarzej	Name kessler	Name kleber	

Valid for Item-No.: 781866, 781716, 781726, 781736, 781741, 781743, 781745, 781746, 781752, 781756, 781757, 781766, 781866-128

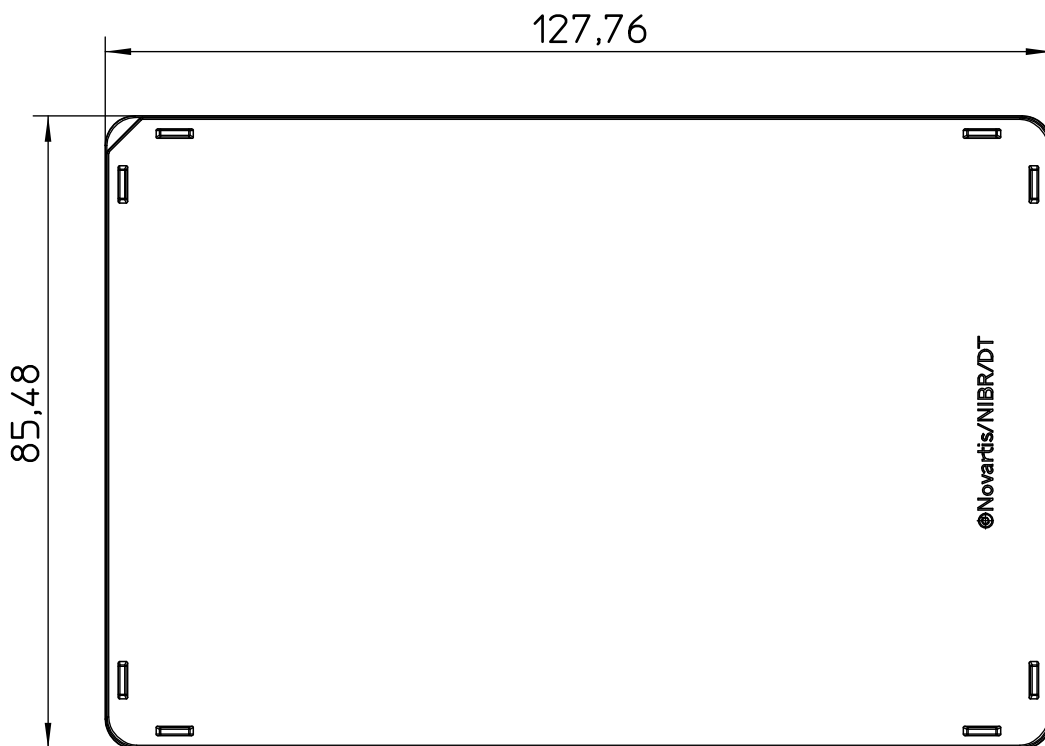
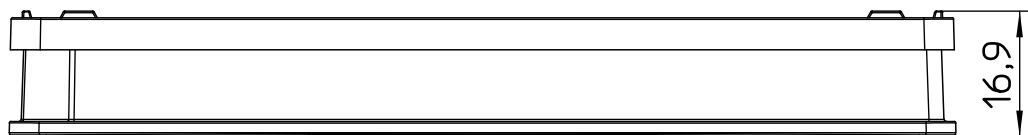
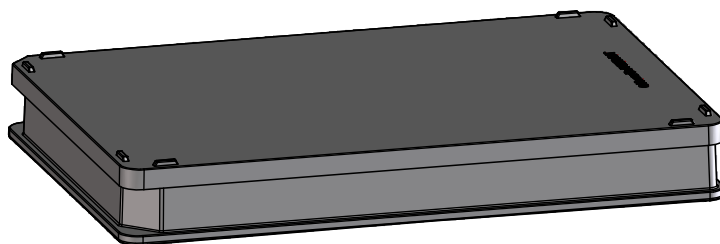

"All dimensions in mm"

Customer drawing subject to change without notice!

Uncontrolled Copy

Prior Issue	Drawn	Approved	Released	CONFIDENTIAL: Information contained in this document or drawing is confidential and proprietary to Greiner Bio-One GmbH. This document may not be reproduced for any reason without written permission from Greiner Bio-One GmbH. All rights of design, invention, and copyright are reserved.
Revision 2	Date 2017/01/25	Date 2024/02/19	Date 2024/02/19	
Date 2024/02/14	Name schwarzj	Name kessler	Name kleber	