

Valid for Item-No.: 782080, 782086, 782180

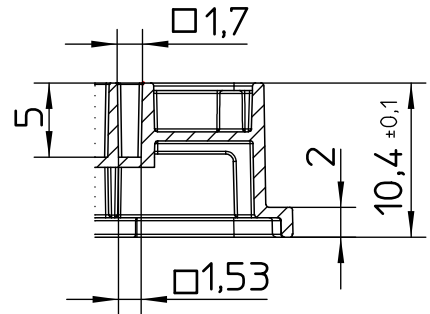

Curvature \updownarrow Max.Diff 0,15

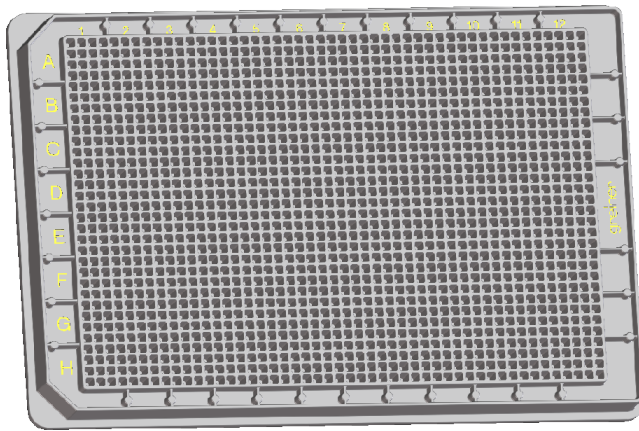
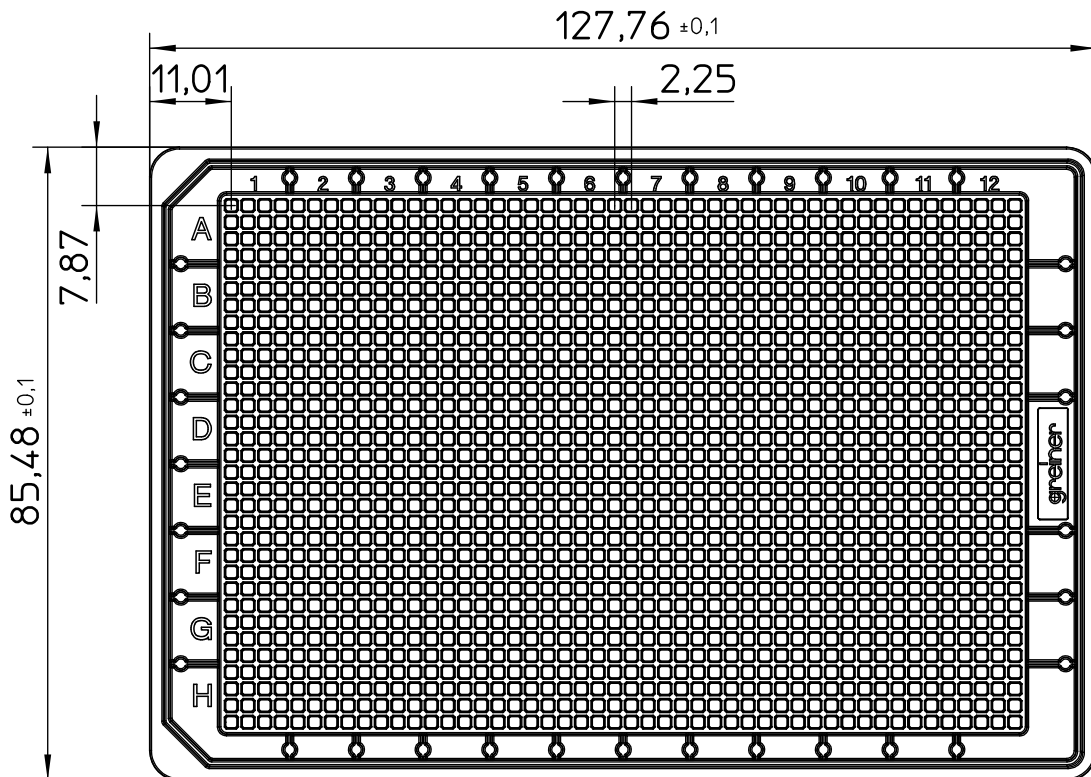
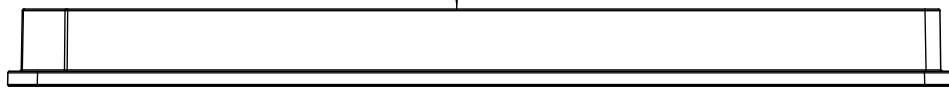

"All dimensions in mm"

Customer drawing subject to change without notice!

Uncontrolled Copy

Prior Issue	Drawn	Approved	Released	CONFIDENTIAL: Information contained in this document or drawing is confidential and proprietary to Greiner Bio-One GmbH. This document may not be reproduced for any reason without written permission from Greiner Bio-One GmbH. All rights of design, invention, and copyright are reserved.
Revision 5	Date 2011/03/23	Date 2021/12/06	Date 2021/12/06	
Date 2020/04/06	Name forb	Name forb	Name kessler	

Valid for Item-No.: 782080, 782086, 782180

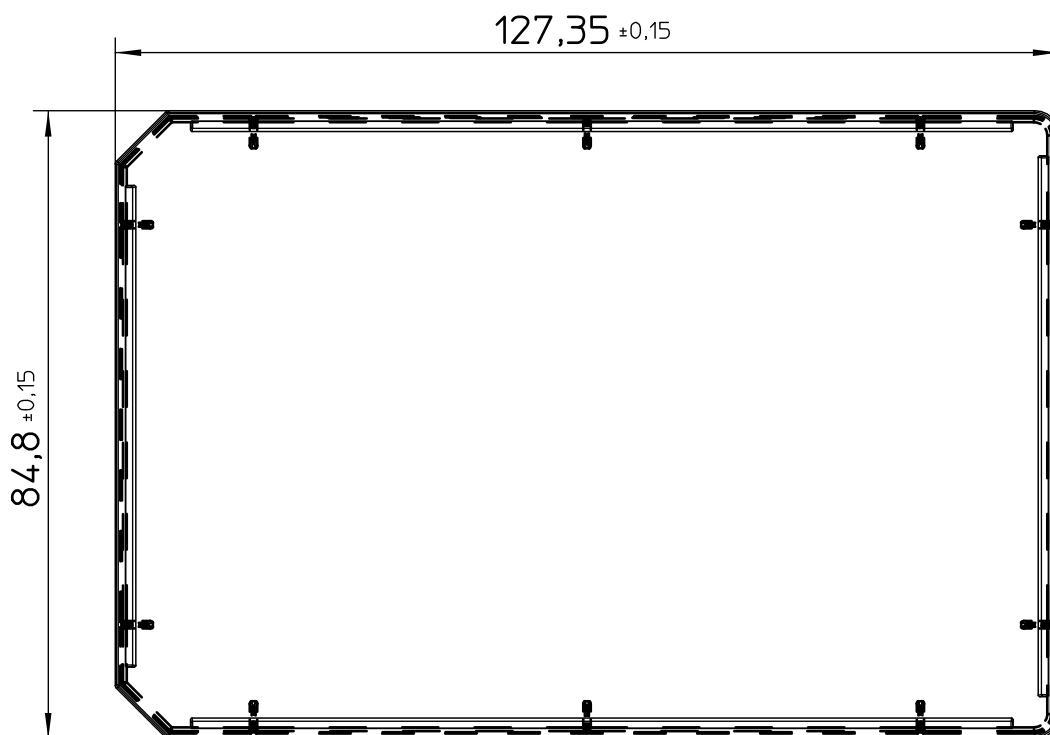
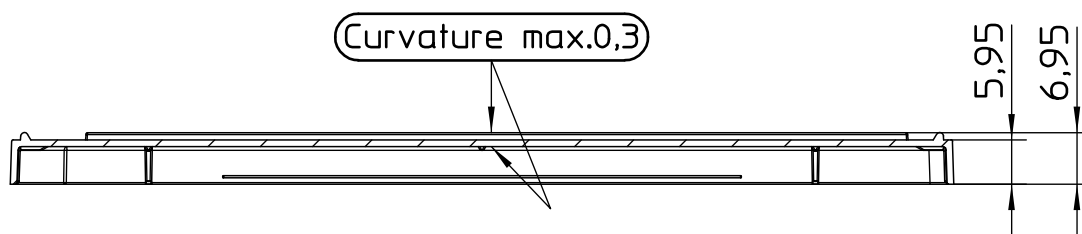
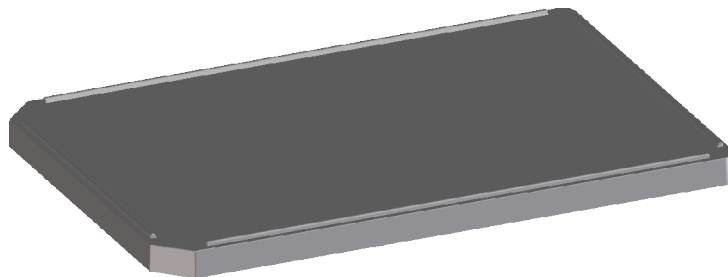

"All dimensions in mm"
Customer drawing subject to change without notice!

Uncontrolled Copy

Prior Issue	Drawn	Approved	Released	CONFIDENTIAL: Information contained in this document or drawing is confidential and proprietary to Greiner Bio-One GmbH. This document may not be reproduced for any reason without written permission from Greiner Bio-One GmbH. All rights of design, invention, and copyright are reserved.
Revision 5	Date 2011/03/23	Date 2021/12/06	Date 2021/12/06	
Date 2020/04/06	Name forb	Name forb	Name kessler	