

Valid for Item-No.: 132201, 132202, 132263, 132202-2D1, 132263-2D1

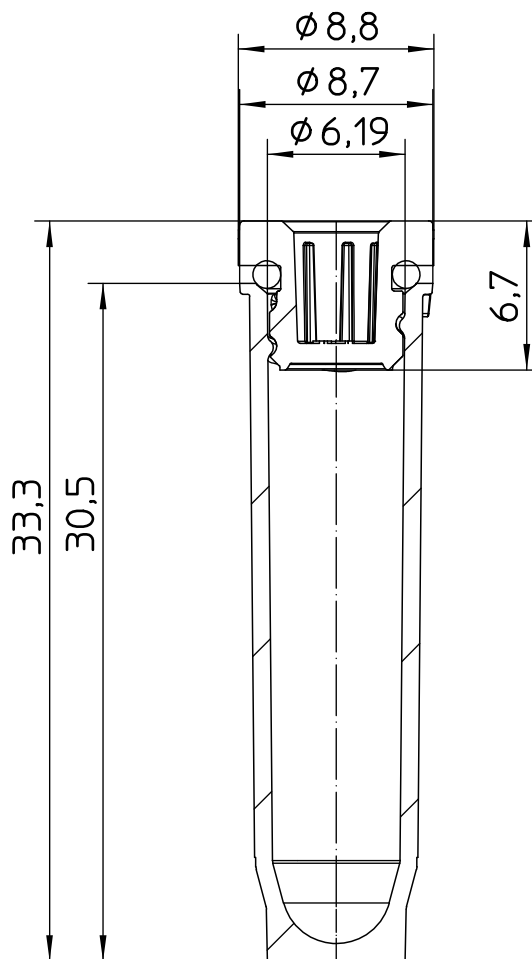

"All dimensions in mm"

Customer drawing subject to change without notice!

Uncontrolled Copy

Prior Issue	Drawn	Approved	Released	CONFIDENTIAL: Information contained in this document or drawing is confidential and proprietary to Greiner Bio-One GmbH. This document may not be reproduced for any reason without written permission from Greiner Bio-One GmbH. All rights of design, invention, and copyright are reserved.
Revision	Date	Date	Date	
3	2014/09/29	2023/04/26	2023/04/26	
Date	Name	Name	Name	
2022/11/08	forb	forb	kleber	