

Valid for Item-No.: 657102, 657910, 657920, 657930, 657940, 657950, 657960, 657970

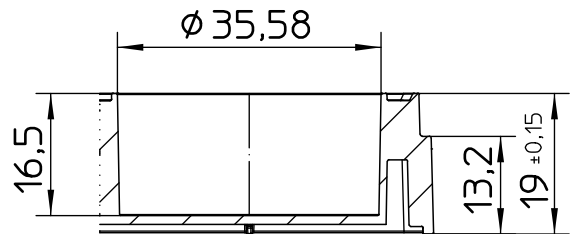

Curvature  $\updownarrow$  Max.Diff 0.20

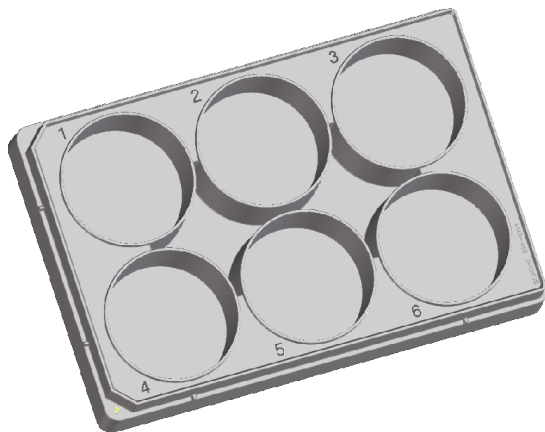
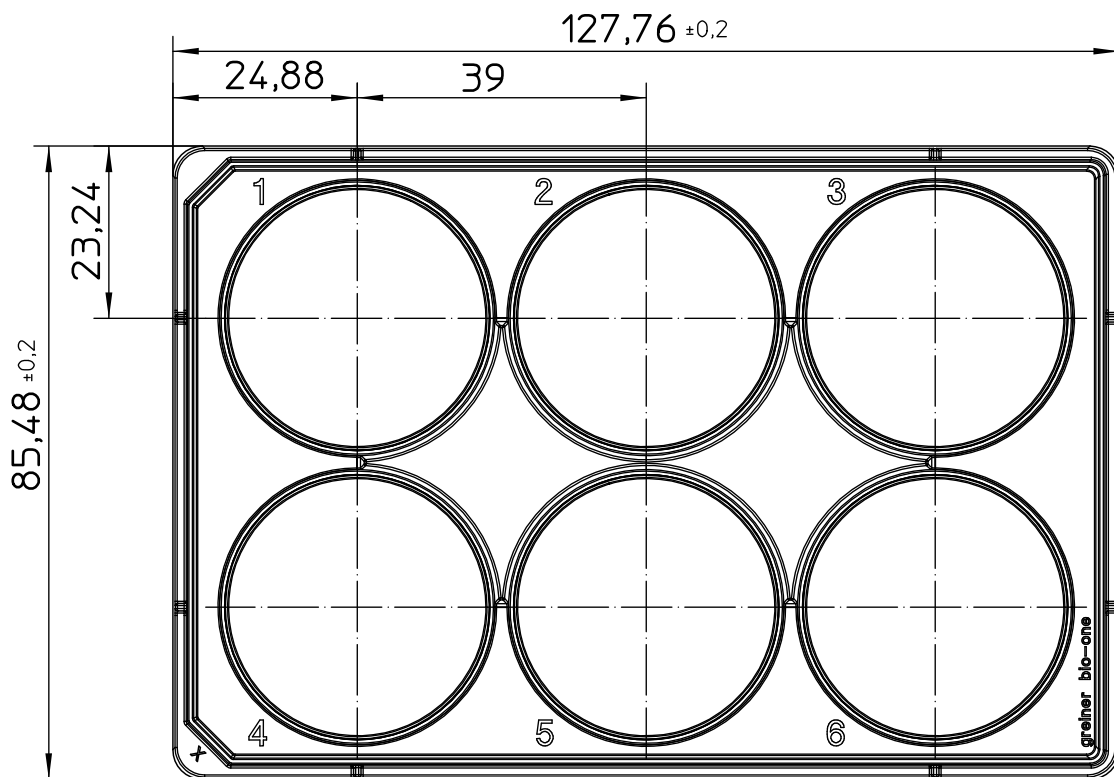
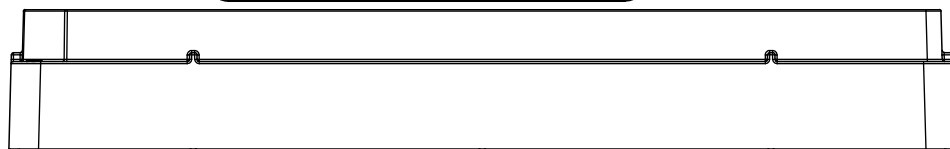

"All dimensions in mm"

Customer drawing subject to change without notice!

Uncontrolled Copy

Prior Issue	Drawn	Approved	Released	CONFIDENTIAL: Information contained in this document or drawing is confidential and proprietary to Greiner Bio-One GmbH. This document may not be reproduced for any reason without written permission from Greiner Bio-One GmbH. All rights of design, invention, and copyright are reserved.
Revision 4	Date 2018/11/19	Date 2022/11/08	Date 2022/11/08	
Date 2020/03/11	Name forb	Name forb	Name kleber	

Valid for Item-No.: 657102, 657910, 657920, 657930, 657940, 657950, 657960, 657970

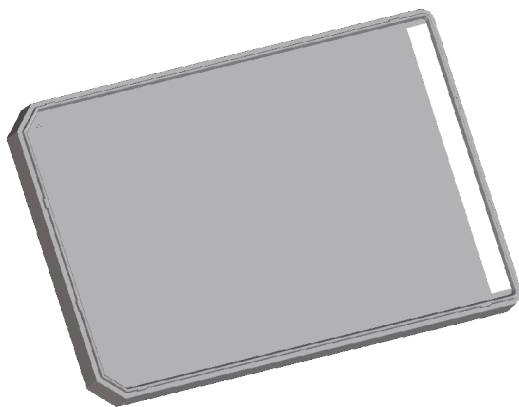

Curvature +0.3  
-0.1

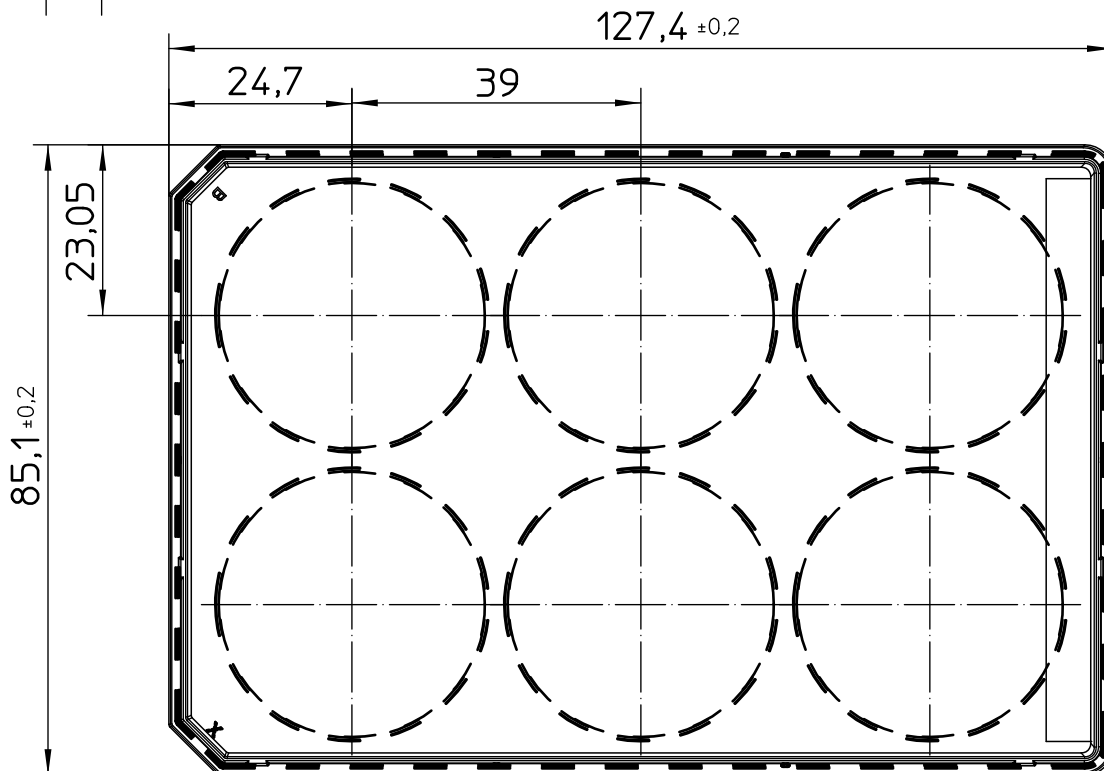
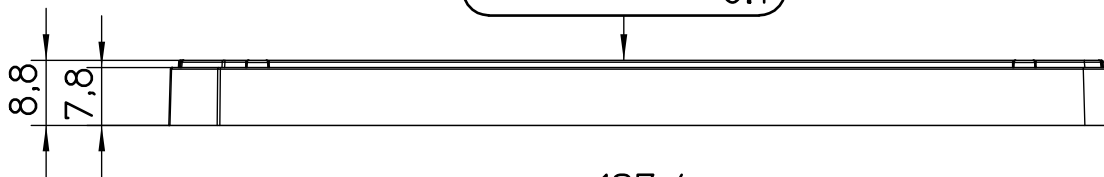

"All dimensions in mm"

Customer drawing subject to change without notice!

Uncontrolled Copy

Prior Issue	Drawn	Approved	Released	CONFIDENTIAL: Information contained in this document or drawing is confidential and proprietary to Greiner Bio-One GmbH. This document may not be reproduced for any reason without written permission from Greiner Bio-One GmbH. All rights of design, invention, and copyright are reserved.
Revision 4	Date 2018/11/19	Date 2022/11/08	Date 2022/11/08	
Date 2020/03/11	Name forb	Name forb	Name kleber	