

Valid for Item-No.: 781073, 781074, 781075, 781076, 781077, 781079, 781080, 781086

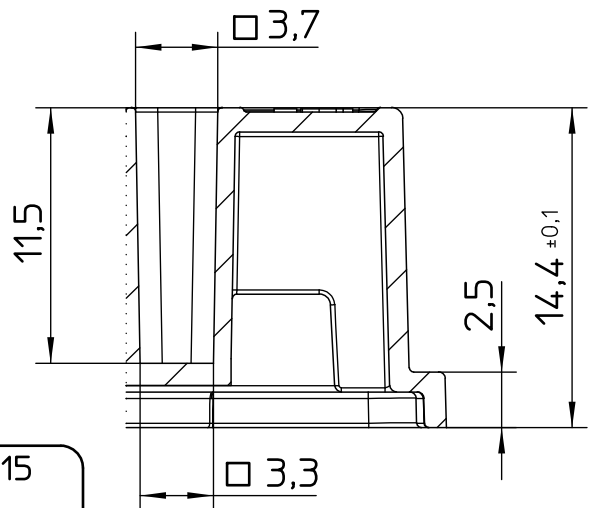

Curvature +0,15
-0,15

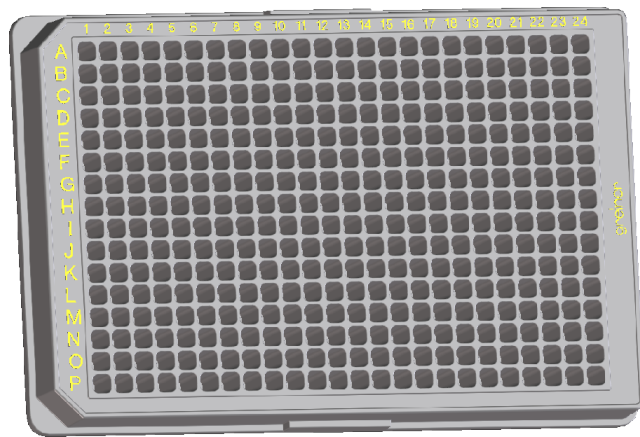
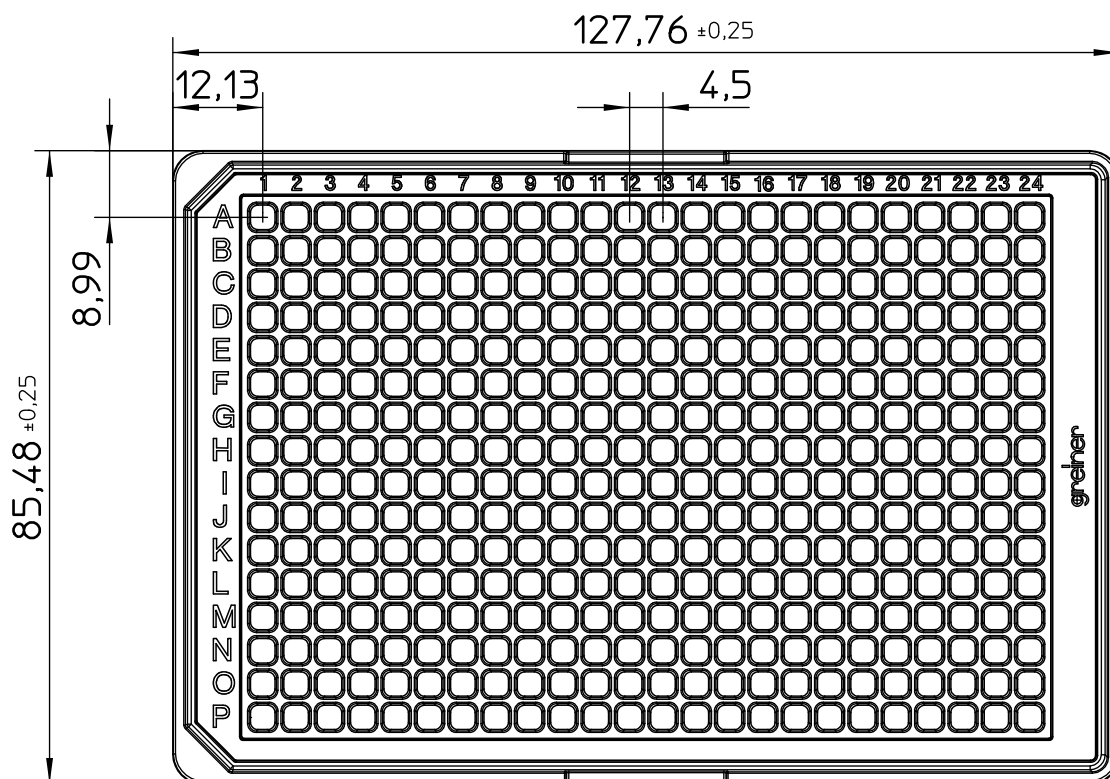
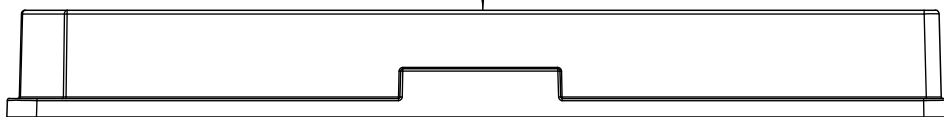

"All dimensions in mm"

Customer drawing subject to change without notice!

Uncontrolled Copy

Prior Issue	Drawn	Approved	Released	CONFIDENTIAL: Information contained in this document or drawing is confidential and proprietary to Greiner Bio-One GmbH. This document may not be reproduced for any reason without written permission from Greiner Bio-One GmbH. All rights of design, invention, and copyright are reserved.
Revision 5	Date 2011/03/23	Date 2024/07/16	Date 2024/07/16	
Date 2021/07/28	Name forb	Name kleber	Name ziegler	

Valid for Item-No.: 781073, 781074, 781075, 781076, 781077, 781079, 781080, 781086

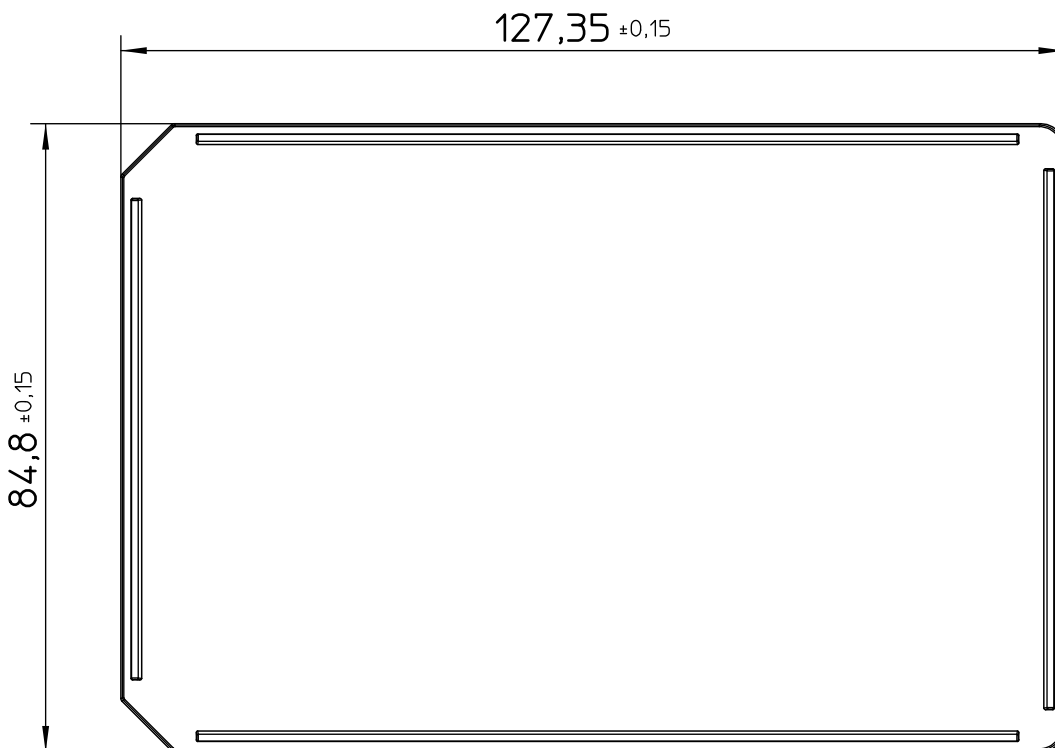
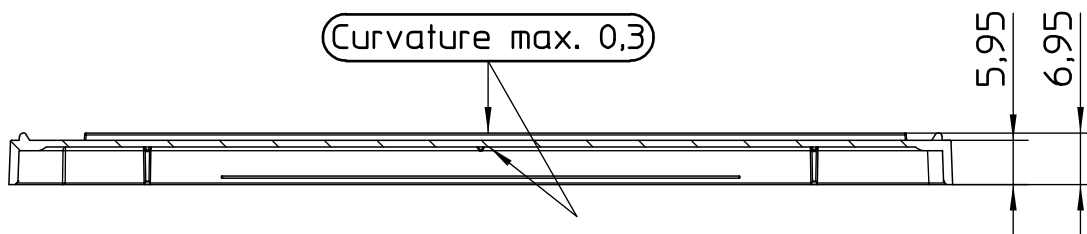
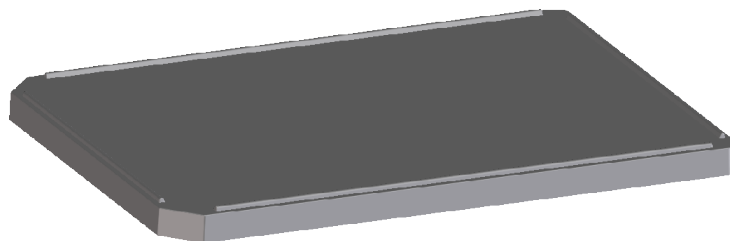

Only Item-No. 781080, 781086 with lid

"All dimensions in mm"
Customer drawing subject to change without notice!

Uncontrolled Copy

Prior Issue	Drawn	Approved	Released	CONFIDENTIAL: Information contained in this document or drawing is confidential and proprietary to Greiner Bio-One GmbH. This document may not be reproduced for any reason without written permission from Greiner Bio-One GmbH. All rights of design, invention, and copyright are reserved.
Revision	Date	Date	Date	
5	2011/03/23	2024/07/16	2024/07/16	
Date	Name	Name	Name	
2021/07/28	forb	kleber	ziegler	