

Valid for Item-No.: 651101, 651160, 651161, 651180

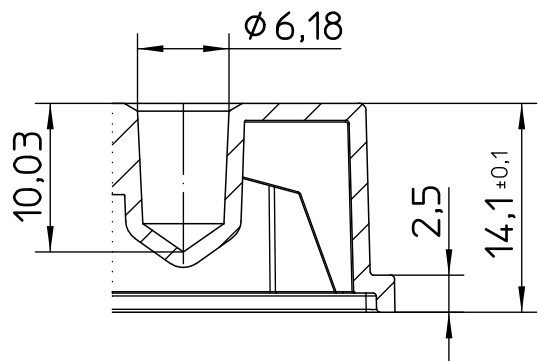

Curvature max.0,2

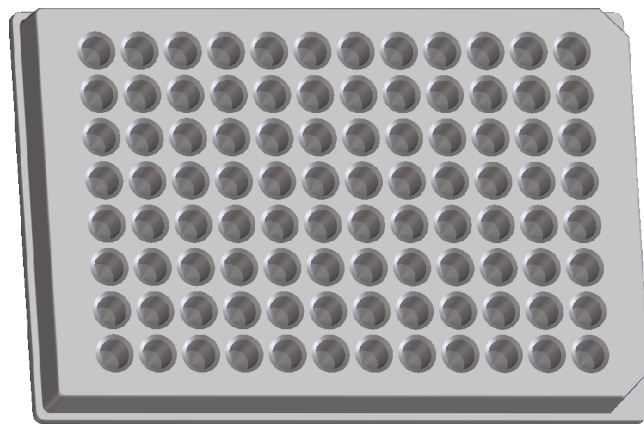
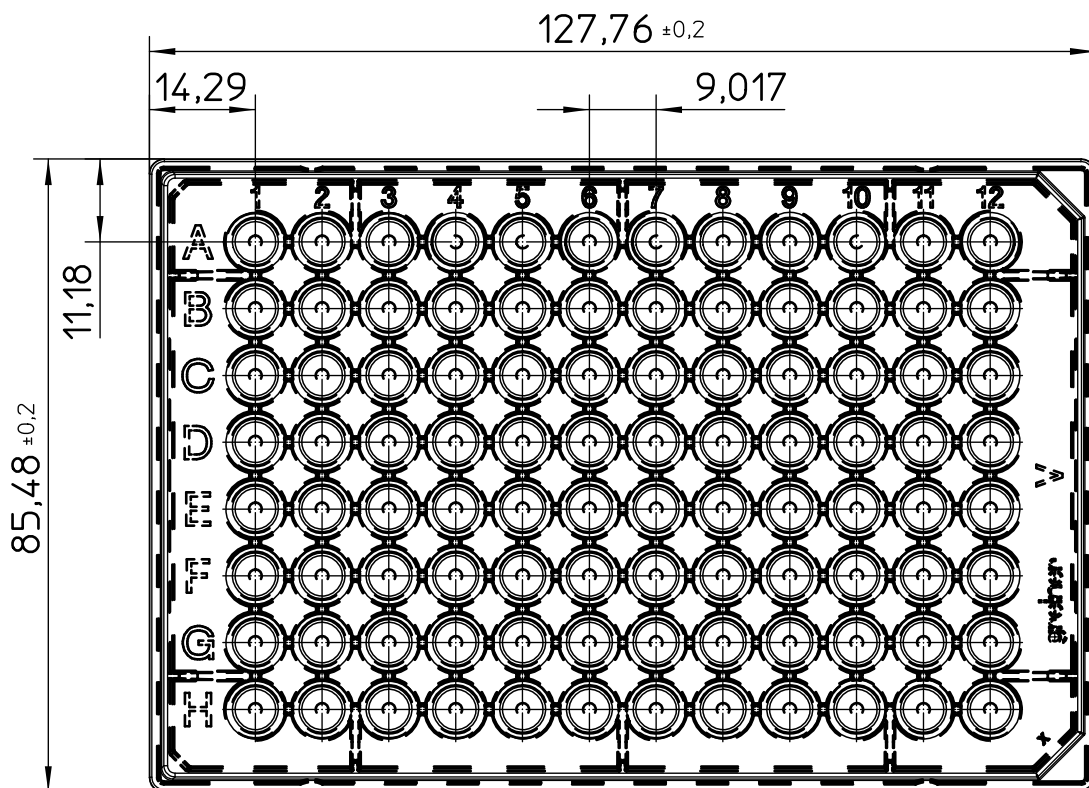
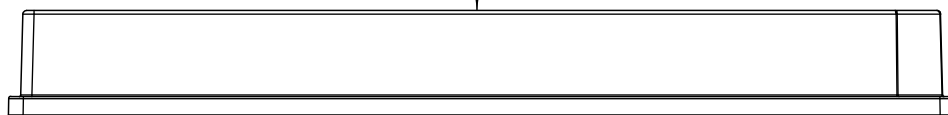

"All dimensions in mm"

Customer drawing subject to change without notice!

Uncontrolled Copy

Prior Issue	Drawn	Approved	Released	CONFIDENTIAL: Information contained in this document or drawing is confidential and proprietary to Greiner Bio-One GmbH. This document may not be reproduced for any reason without written permission from Greiner Bio-One GmbH. All rights of design, invention, and copyright are reserved.
Revision 2	Date 2015/03/16	Date 2021/09/28	Date 2021/09/29	
Date 2017/02/23	Name schwarzj	Name forb	Name schwarzj	

Valid for Item-No.: 651101, 651160, 651161, 651180

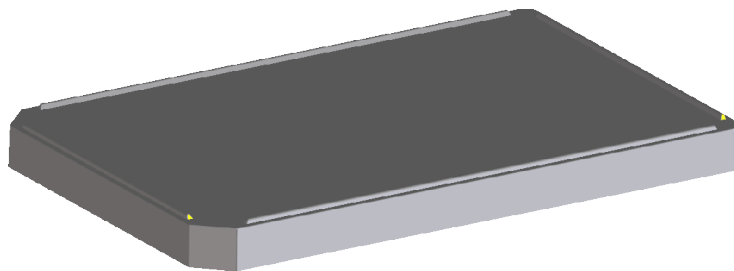

Curvature +0,3
-0,3

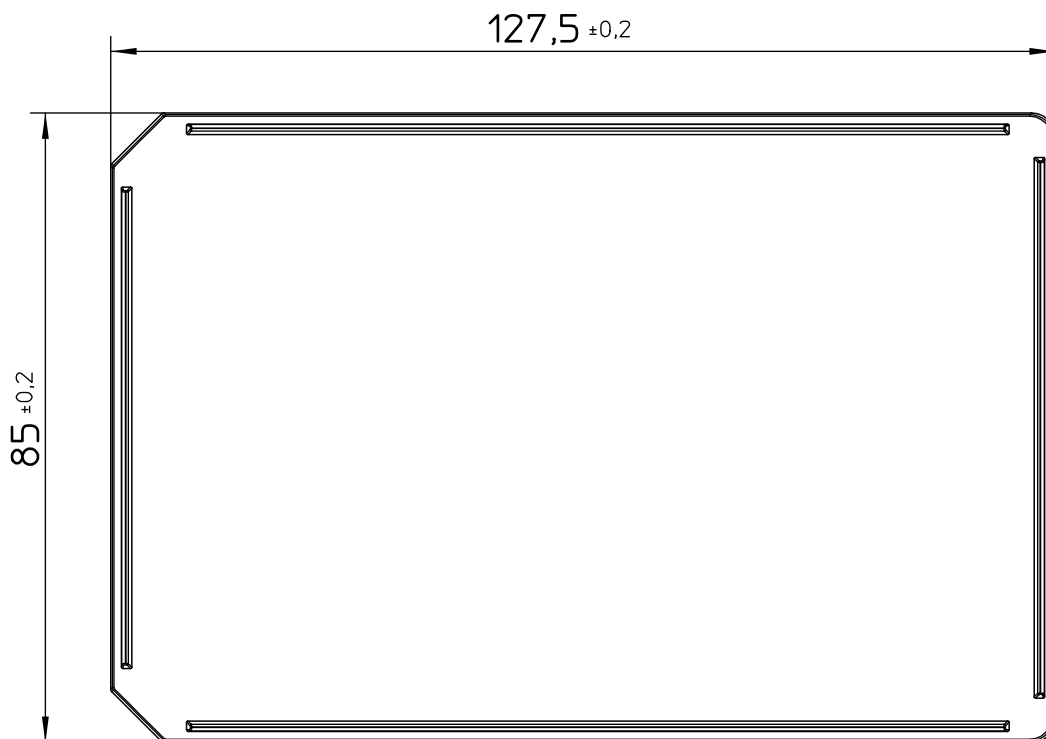
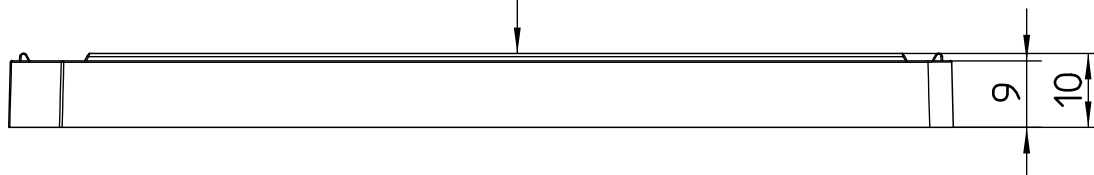

Only Part.-No. 651180 with lid

"All dimensions in mm"
Customer drawing subject to change without notice!

Uncontrolled Copy

Prior Issue	Drawn	Approved	Released	CONFIDENTIAL: Information contained in this document or drawing is confidential and proprietary to Greiner Bio-One GmbH. This document may not be reproduced for any reason without written permission from Greiner Bio-One GmbH. All rights of design, invention, and copyright are reserved.
Revision 2	Date 2015/03/16	Date 2021/09/28	Date 2021/09/29	
Date 2017/02/23	Name schwarzj	Name forb	Name schwarzj	