

Valid for Item-No.: 655990, 655997

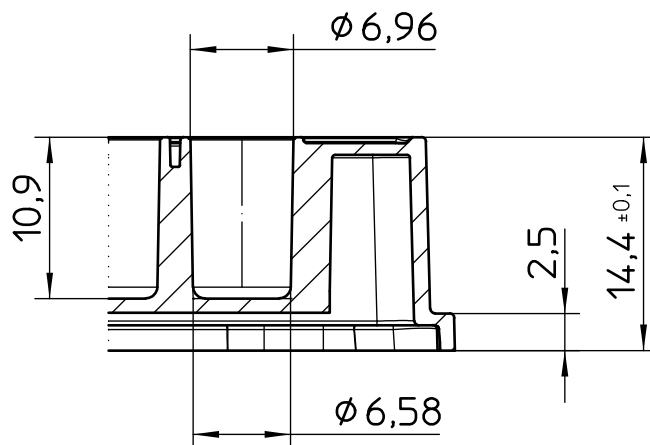

Curvature max.0,2

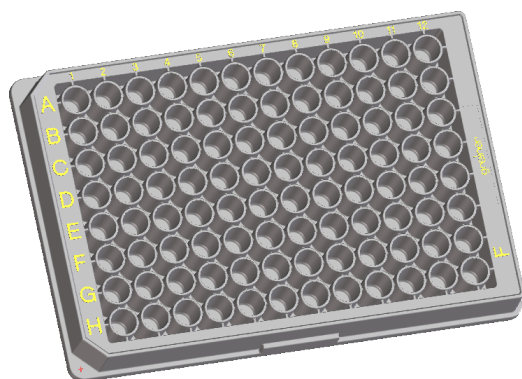
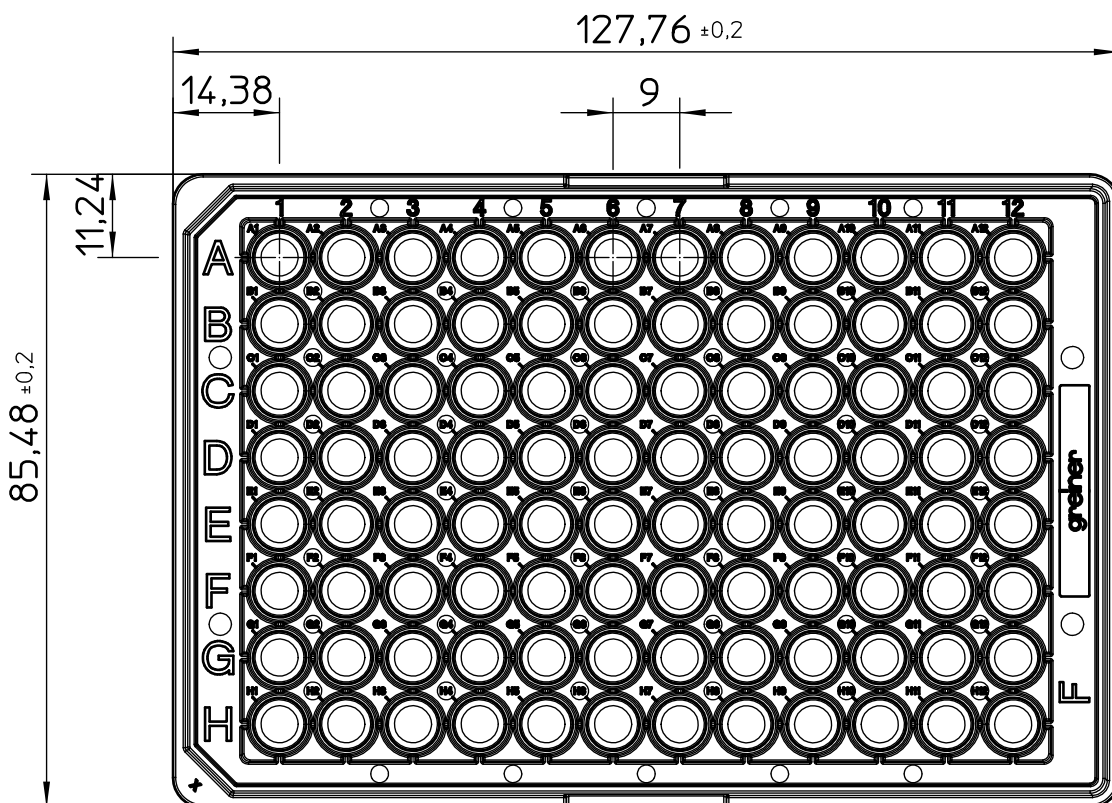
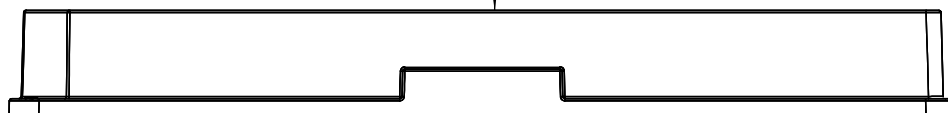

"All dimensions in mm"

Customer drawing subject to change without notice!

Uncontrolled Copy

Prior Issue	Drawn	Approved	Released	CONFIDENTIAL: Information contained in this document or drawing is confidential and proprietary to Greiner Bio-One GmbH. This document may not be reproduced for any reason without written permission from Greiner Bio-One GmbH. All rights of design, invention, and copyright are reserved.
Revision 4	Date 2011/06/17	Date 2023/04/19	Date 2023/04/19	
Date 2022/11/14	Name forb	Name forb	Name kleber	