

Valid for Item-No.: 705091, 705092

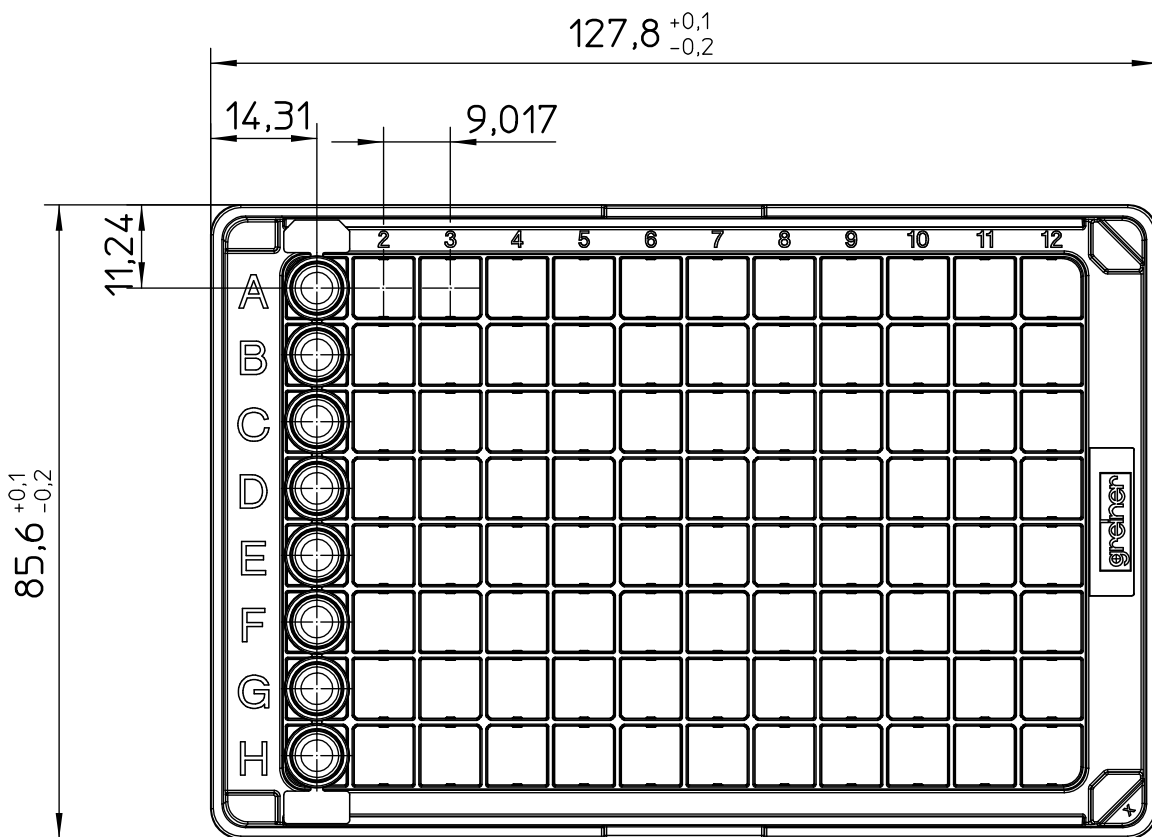
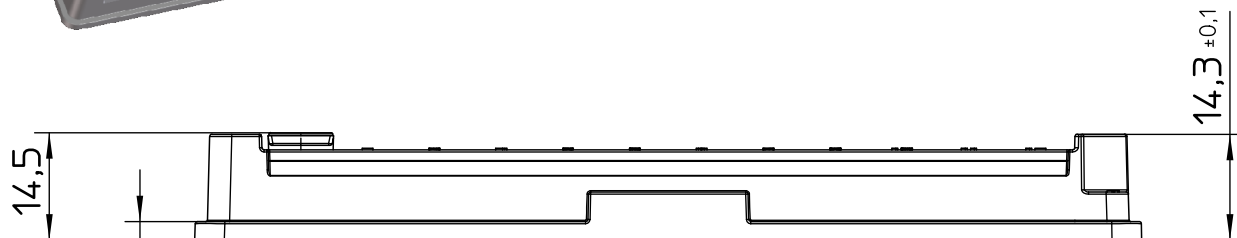
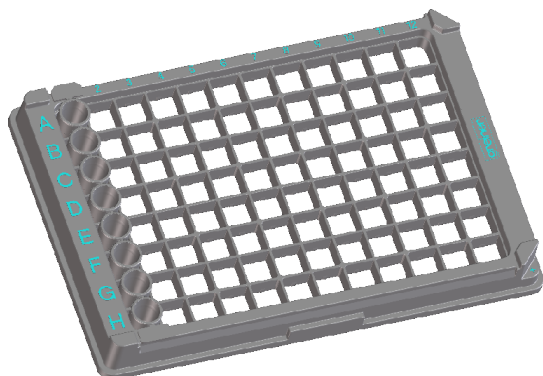

"All dimensions in mm"

Customer drawing subject to change without notice!

Uncontrolled Copy

Prior Issue	Drawn	Approved	Released	CONFIDENTIAL: Information contained in this document or drawing is confidential and proprietary to Greiner Bio-One GmbH. This document may not be reproduced for any reason without written permission from Greiner Bio-One GmbH. All rights of design, invention, and copyright are reserved.
Revision 3	Date 2014/11/24	Date 2025/01/22	Date 2025/01/23	
Date 2020/10/14	Name forb	Name kleber	Name ziegler	

Valid for Item-No.: 705091, 705092

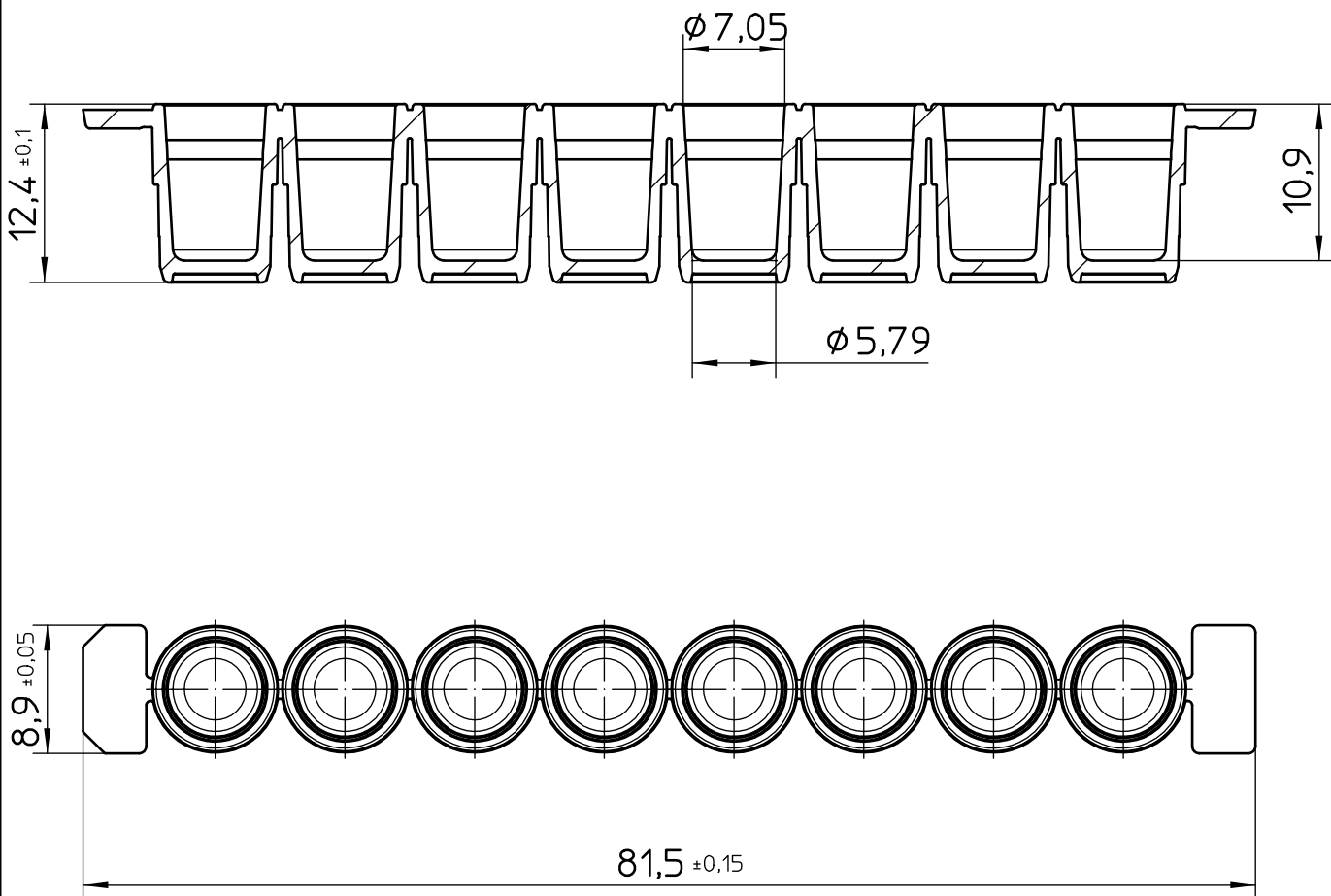

"All dimensions in mm"

Customer drawing subject to change without notice!

Uncontrolled Copy

Prior Issue	Drawn	Approved	Released	CONFIDENTIAL: Information contained in this document or drawing is confidential and proprietary to Greiner Bio-One GmbH. This document may not be reproduced for any reason without written permission from Greiner Bio-One GmbH. All rights of design, invention, and copyright are reserved.
Revision	Date	Date	Date	
3	2014/11/24	2025/01/22	2025/01/23	
Date	Name	Name	Name	
2020/10/14	forb	kleber	ziegler	