

Valid for Item-No.: 788075, 788076, 788095, 788096

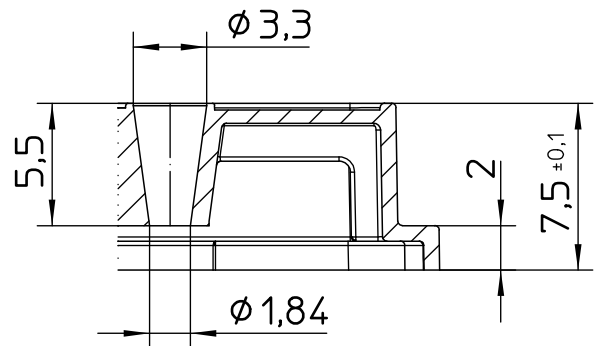

Curvature max.0,15

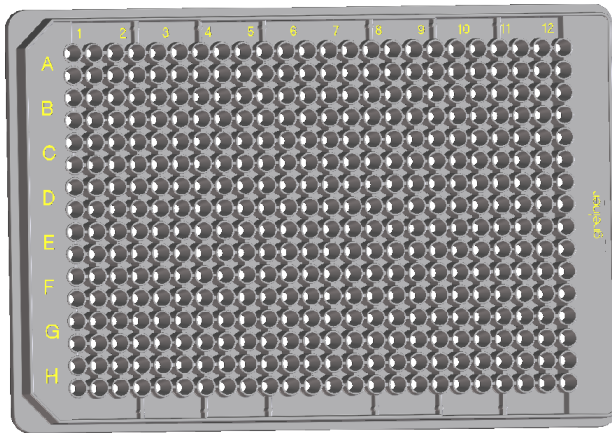
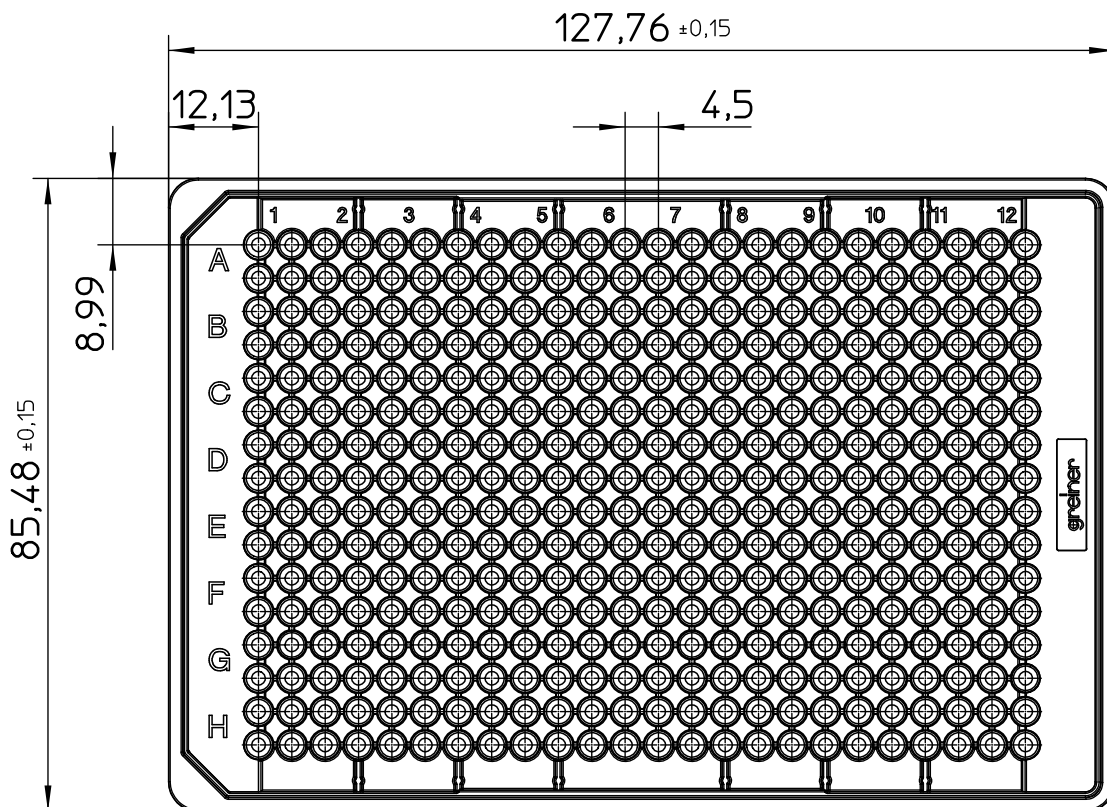
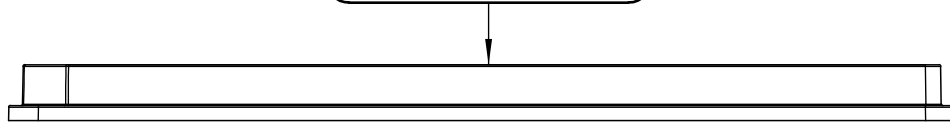

"All dimensions in mm"

Customer drawing subject to change without notice!

Uncontrolled Copy

Prior Issue	Drawn	Approved	Released	CONFIDENTIAL: Information contained in this document or drawing is confidential and proprietary to Greiner Bio-One GmbH. This document may not be reproduced for any reason without written permission from Greiner Bio-One GmbH. All rights of design, invention, and copyright are reserved.
Revision 7	Date 2011/03/22	Date 2021/06/07	Date 2021/06/07	
Date 2019/09/04	Name forb	Name forb	Name kessler	

Valid for Item-No.: 788075, 788076, 788095, 788096

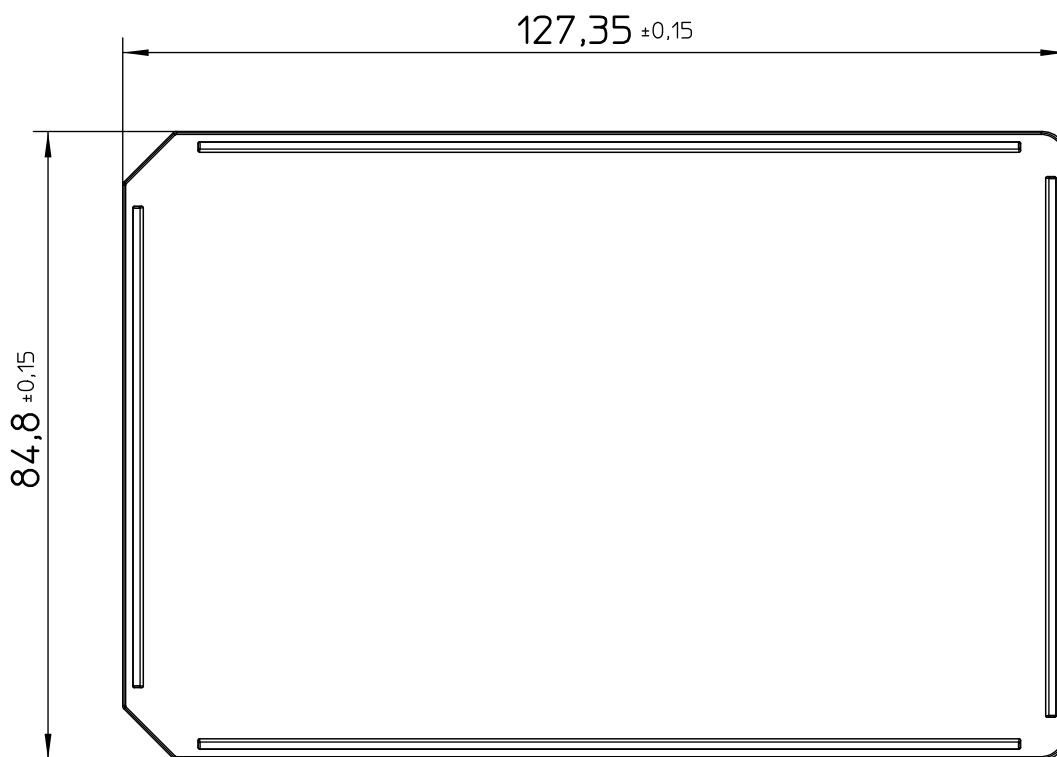
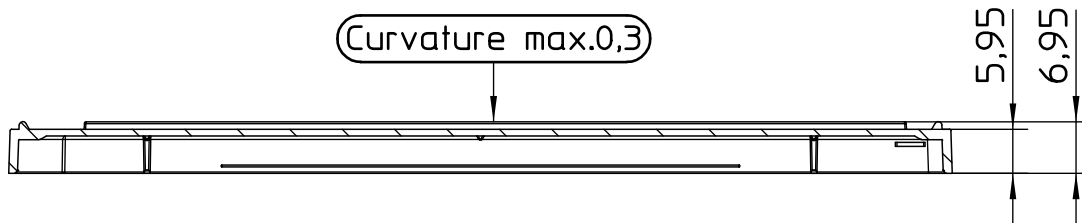
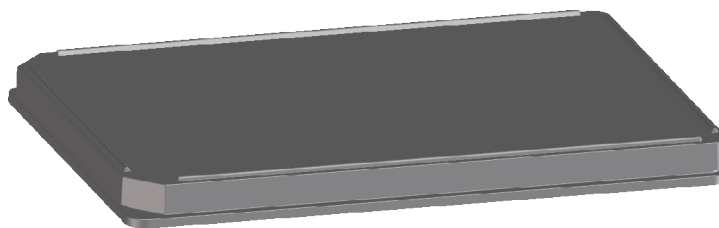

Only Part-No. 788086 with lid

"All dimensions in mm"
Customer drawing subject to change without notice!

Uncontrolled Copy

Prior Issue	Drawn	Approved	Released	CONFIDENTIAL: Information contained in this document or drawing is confidential and proprietary to Greiner Bio-One GmbH. This document may not be reproduced for any reason without written permission from Greiner Bio-One GmbH. All rights of design, invention, and copyright are reserved.
Revision 7	Date 2011/03/22	Date 2021/06/07	Date 2021/06/07	
Date 2019/09/04	Name forb	Name forb	Name kessler	