

Valid for Item-No.: 623201, 623275

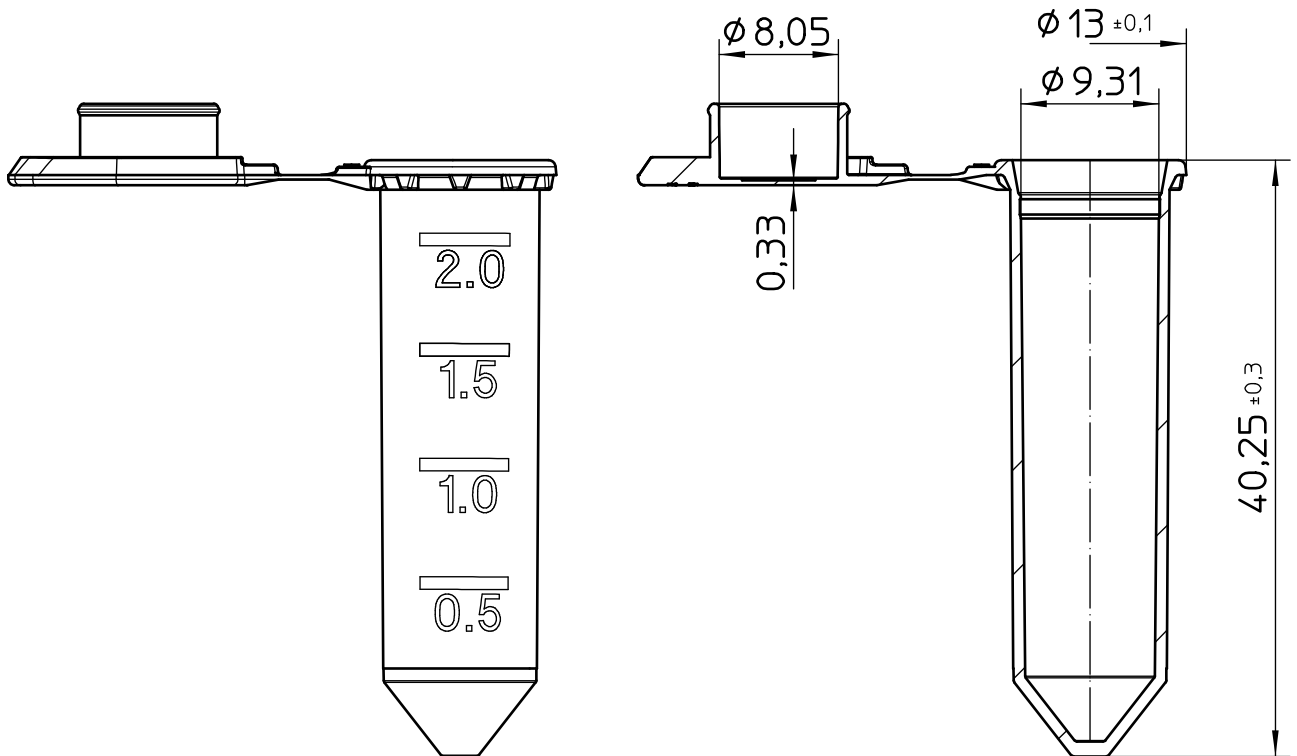

"All dimensions in mm"

Customer drawing subject to change without notice!

Uncontrolled Copy

Prior Issue	Drawn	Approved	Released	CONFIDENTIAL: Information contained in this document or drawing is confidential and proprietary to Greiner Bio-One GmbH. This document may not be reproduced for any reason without written permission from Greiner Bio-One GmbH. All rights of design, invention, and copyright are reserved.
Revision 4	Date 2011/05/17	Date 2024/11/07	Date 2024/11/07	
Date 2023/12/08	Name forb	Name kleber	Name ziegler	